

# **Wessex ModuMax mk2 Boilers**

Condensing  
Fully Modulating, Pre-Mix, Gas Fired,  
Modular Boilers for Heating and  
Domestic Hot Water Installations

## **Installation, Commissioning and Servicing Instructions**

Models– 100c, 120c,  
150c, 200c & 250c

*NATURAL GAS |<sub>2H</sub>*  
*LPG Propane |<sub>3P</sub>*

### **IMPORTANT NOTE**

**THESE INSTRUCTIONS MUST BE READ  
AND UNDERSTOOD BEFORE INSTALLING,  
COMMISSIONING, OPERATING OR  
SERVICING EQUIPMENT**

# Customer After Sales Services

Telephone: **01202 662555** E-mail: **service@hamworthy-heating.com** Fax: **01202 662522**

## **Technical Enquiries**

To supplement the detailed technical brochures, technical advice on the application and use of products in the Hamworthy Heating range is available from our technical team in Poole and our accredited agents.

## **Site Assembly**

Hamworthy offer a service of site assembly for many of our products where plant room access is restricted. Using our trained staff we offer a higher quality of build and assurance of a boiler built and tested by the manufacturer.

## **Commissioning**

Commissioning of equipment by our own engineers, accredited agents or specialist sub-contractors will ensure the equipment is operating safely and efficiently.

## **Service Contracts**

Regular routine servicing of equipment by Hamworthy service engineers inspects the safety and integrity of the plant, reducing the risk of failure and improving performance and efficiency. Service contracts enable you to plan and budget more efficiently.

## **Breakdown service, repair, replacement**

Hamworthy provide a rapid response breakdown, repair or replacement service through head office at Poole and accredited agents throughout the UK.

## **Spare Parts**

We offer a comprehensive range of spare parts, providing replacement parts for both current and discontinued products. Delivery options are available to suit you. Please refer to our website for more details.

# **Wessex ModuMax mk2 Boilers**

**Condensing  
Fully Modulating, Pre-Mix, Gas Fired,  
Modular Boilers for Heating and  
Domestic Hot Water Installations**

## **Installation, Commissioning and Servicing Instructions**

**Models– 100c, 120c,  
150c, 200c & 250c**

*NATURAL GAS |<sub>2H</sub>  
LPG Propane |<sub>3P</sub>*

**NOTE: THESE INSTRUCTIONS MUST BE READ AND UNDERSTOOD BEFORE  
INSTALLING, COMMISSIONING, OPERATING OR SERVICING EQUIPMENT.**

**THE WESSEX ModuMax BOILER IS INTENDED FOR USE AS A COMMERCIAL  
APPLIANCE.**

**THIS BOILER IS FOR USE ON GROUP H NATURAL GAS (2<sup>ND</sup> FAMILY) I<sub>2H</sub> and LPG  
PROPANE (3RD FAMILY) I<sub>3P</sub>. PLEASE ENSURE RELEVANT INFORMATION REQUIRED  
WITHIN DOCUMENT IS FOUND RELATING TO SPECIFIC GAS TO BE FIRED BEFORE  
FIRING BOILER.**

**COUNTRY OF DESTINATION : UNITED KINGDOM & REPUBLIC OF IRELAND**

THIS BOILER COMPLIES WITH ALL RELEVANT EUROPEAN DIRECTIVES.

PRODUCT IDENTIFICATION No. 86CL31

**PUBLICATION NO. 500001296  
ISSUE 'C'  
September 2015**

## CONTENTS

	PAGE
<b>1.0 INTRODUCTION .....</b>	<b>1</b>
<b>2.0 SUPPLY AND DELIVERY .....</b>	<b>3</b>
<b>3.0 SIZE AND SPACE REQUIREMENTS .....</b>	<b>6</b>
<b>4.0 SITE LOCATION AND PREPARATION .....</b>	<b>10</b>
4.1 Site Location	
4.2 Gas Supply	
4.3 Flueing	
4.4 Water Supply	
4.5 Condensate Connections	
4.6 Electrical Supply	
<b>5.0 BOILER ASSEMBLY .....</b>	<b>15</b>
5.1 Flue Collector Box Assembly	
5.2 Water Connections	
5.3 Electrical Connections	
<b>6.0 PRE-COMMISSIONING .....</b>	<b>17</b>
6.1 Gas Supply	
6.2 Ventilation	
6.3 Pipework, Valves and Pump	
6.4 Flue	
6.5 Electrical	
<b>7.0 CHECKS PRIOR TO LIGHTING .....</b>	<b>18</b>
<b>8.0 INITIAL LIGHTING .....</b>	<b>21</b>
8.1 Pre-Lighting-up Checks	
8.2 Controls Operation	
8.3 Ignition Controller Check	
8.4 Gas Supply Pressure Check	
8.5 Combustion Checks	
8.6 User Instructions	
<b>9.0 FAULT FINDING .....</b>	<b>40</b>
9.1 Temperature Limit Thermostat	
9.2 Ignition Controller	
<b>10.0 SERVICING .....</b>	<b>42</b>
10.1 Regular Servicing	
10.2 Annual Service	
10.3 Four Year Service	
<b>11.0 REPLACEMENT OF FAILED COMPONENTS .....</b>	<b>44</b>
11.1 Hot Surface Ignitor and Flame Probe Assembly	
11.2 Flow/Return Sensor	
11.3 Temperature Limiter	
11.4 Gas Valve	
11.5 Combustion Fan	
11.6 Venturi	
11.7 Burner	
11.8 Ignition Transformer	
11.9 Ignition Controller - LMU	
11.10 Clip in Modules	
11.11 Screen Display	
11.12 Low Gas Pressure Switch	
11.13 Air Pressure Switch	
11.14 Ignition Transformer In-line Fuse	
<b>12.0 RECOMMENDED SPARES .....</b>	<b>48</b>

## PICTORIAL AND DIAGRAMMATICAL DATA

	PAGE
Figure 2.1	Boiler Delivery ..... 3
Figure 2.2	Boiler Positioning ..... 3
Figure 2.3	Boiler Packaged Dimensions ..... 4
Figure 2.4	Reverse Header Kit as Supplied ..... 5
Figure 2.5	Header Kit Packaged Dimensions ..... 5
Figure 3.1.1	Dimensions & Clearances Modumax 100c/120c ..... 6
Figure 3.1.2	Dimensions & Clearances Modumax 150c/200c/250c ..... 7
Figure 3.2.1.1	Manifold Dimensions ModuMax 100/200c, 120/240c ..... 8
Figure 3.2.1.2	Manifold Dimensions ModuMax 100/300c, 120/360c ..... 8
Figure 3.2.2.1	Manifold Dimensions ModuMax 150/300c, 200/400c, 250/500c ..... 9
Figure 3.2.2.2	Manifold Dimensions ModuMax 150/450c, 200/600c, 250/750c ..... 9
Figure 4.2	Gas Connection Point ..... 10
Figure 4.4.	Water & Flue Connection Points ..... 12
Figure 4.5.1	Condensate Piping Installation ..... 13
Figure 4.5.2	Condensate Connections ..... 13
Figure 4.6	Electrical Connections ..... 14
Figure 5.1	Flue Collector Box Pre-Assembly ..... 15
Figure 5.2.1	Rear of Boiler Connections (General Overview) ..... 15
Figure 5.2.2	Flue Header Connection ..... 16
Figure 7.1	Boiler Gas System Leak Check Diagram ..... 18
Figure 7.2.1	Gas Valve Position ..... 19
Figure 7.2.2	Venturi -150c/200c/250c Boiler ..... 19
Figure 7.2.3	Hot Surface Ignitor Resistance Check ..... 20
Figure 8.1.1	Gas Valve ..... 21
Figure 8.1.2	General Overview of Low Gas Inlet Pressure Switch ..... 21
Figure 8.1.5	General Overview of Panel Fascia ..... 22
Figure 8.1.6	General Overview of Controls ..... 22
Figure 8.1.7	Location Of Safety Temperature Limiter Reset Button ..... 23
Figure 8.2	System Configuration of Boiler Control ..... 24
Figure 8.2.1.1	Fascia Label Legend ..... 24
Figure 8.2.1.2	Info Display Parameters ..... 26
Figure 8.2.1.3	Operation and Display Philosophy ..... 27
Figure 8.2.2	Screen Legend ..... 28
Figure 8.2.3.1	Default Display ..... 29
Figure 8.2.3.2	Display of Status Code ..... 29
Figure 8.2.4	Display of Lockout Code ..... 30
Figure 8.2.5	Heating Circuit Set point Temperature ..... 30
Figure 8.2.6	Overview of End user Parameters ..... 31
Figure 8.2.9	Operating Mode ..... 32
Figure 8.2.10	Error Code Display ..... 34
Figure 8.3.10	LMU Fault Log ..... 35
Figure 8.3.11	Operating Phases ..... 36
Figure 8.3.12	Operating Phases ..... 37
Figure 8.6.1	Removal of Sample Point Plug ..... 38
Figure 8.6.2	Combustion Analyser Probe Setting ..... 38
Figure 8.6.3	Insertion of Analyser Probe ..... 38
Figure 8.6.4	High Fire Setting ..... 39
Figure 8.6.5	Low Fire Setting ..... 39
Figure 9.3.2	Wiring Diagram ..... 41
Figure 10.2	Hot Surface Ignitor and Flame Probe Positions ..... 43
Figure 11.3	Identification of temp limiters and their wiring connections ..... 45
Figure 11.4	Ignition Transformer In-line Fuse ..... 47

## APPENDICES

		PAGE
<b>APPENDIX A</b>	<b>GAS DATA</b> .....	<b>49</b>
Figure A	General Gas Data .....	49
<b>APPENDIX B</b>	<b>ELECTRICAL CONNECTIONS AND CONTROLS</b> .....	<b>50</b>
Figure B	General Electrical Data .....	50
Figure B1.2	External Control Wiring for Multiple Module Installations.....	51
<b>APPENDIX C</b>	<b>FLUE DATA</b> .....	<b>52</b>
Figure C	Flue Data Table.....	52
Figure C1.1.1	Equivalent Flue Resistance Data .....	54
Figure C1.1.2	Open Natural Draught (B23) Flue System .....	55
Figure C1.1.3	Room Sealed (B53) Flue System.....	56
<b>APPENDIX D</b>	<b>VENTILATION</b> .....	<b>57</b>
Figure D1	Mechanical Ventilation Flow Rates Chart .....	58
<b>APPENDIX E</b>	<b>WATER DATA</b> .....	<b>59</b>
Figure E1.1	General Water Data .....	59
Figure E1.1.1	Typical Piping Layout .....	61
Figure E1.3	Cold Feed and Vent Pipe Sizes Table .....	62
<b>Figure E1.3.1</b>	Schematic for Single Boiler System .....	<b>63</b>
<b>Figure E1.3.2</b>	Schematic for Single Boiler, Primary Circuit System .....	<b>63</b>
<b>Figure E1.3.3</b>	Schematic for Single Boiler (External 0~10V) Multi Circuit System .....	<b>64</b>
<b>Figure E1.3.4</b>	Schematic for Multiple Boiler (Cascade) Primary Circuit System .....	<b>64</b>

## **1.0 INTRODUCTION**

1.1 This boiler must be installed by a competent person.

1.1.2 All installations **MUST** conform to the relevant Gas Safety and Building Regulations.

1.1.3 Health & Safety requirements must also be taken into account when installing any equipment.

1.1.4 Failure to comply with the above may lead to prosecution.

1.2 This boiler is intended for use on Group H Natural Gas (2nd Family) I<sub>2H</sub> or LPG Propane (3rd Family) I<sub>3P</sub> for condensing models only.

1.2.1 The information relating to Natural Gas & Propane firing is to be found in Appendix 'A'.

1.2.2 Boilers **MUST NOT** use gas other than that for which they are designed and adjusted.

1.3 The Wessex ModuMax is a gas fired, fully modulating, condensing or high efficiency, fan assisted, open flued or room sealed central heating / hot water boiler. Using the latest gas / air ratio control technology it is able to provide clean efficient operation across a large output range.

1.3.1 The boiler can be supplied in a modular format, a maximum of three vertically stacked modules being arranged into a single unit sharing a common flue.

1.3.2 Each boiler module utilises a metal fibre, fan assisted, pre-mix burner.

1.3.3 Operation is initiated and controlled by a LMU boiler management system with a user interface LCD display for accessing and changing boiler parameters.

1.3.4 Each of the boiler models is designed for direct connection to a flue system. The Technical Data for the various arrangements is given in Appendix 'C'. The flue outlets from more than one unit may be connected to a single chimney.

No draught diverter is fitted to the boiler nor is a fixed diverter required in the flue system. However a draught stabiliser is recommended for some installations.

1.3.5 The Wessex ModuMax is floor mounted and is intended for the heating of Commercial and Industrial premises. It may also be used to supply hot water for these premises via an indirect cylinder.

1.3.6 The Wessex ModuMax has a low water content and water flow rates **MUST** be maintained at or above the recommended levels shown in Appendix 'E'.

1.4 If the boiler is to be connected to an un-vented (pressurised) heating system, care must be taken to ensure all extra safety requirements are satisfied and that the relevant interlocks will shut the boiler(s) off should a high or low pressure fault occur.

1.4.1 The pressurisation unit must also incorporate a low level water switch which protects the water pumps and will directly or indirectly shut down the boiler plant should a low water condition occur.

1.4.2 Consideration should also be given to the maximum working pressure of the boiler as given in Appendix 'E'.

Consult Hamworthy Heating Technical Department for help or assistance if in doubt.

1.5 The Wessex ModuMax boiler is not suitable for direct connection to domestic hot water supplies.

1.6 The Wessex ModuMax boiler can be installed with either reverse return water flow, (optional kits available) or with single pipe headers, (non HHL supply).

See Appendix 'E', figure E1.1.1 for typical schematic layout.

## BOILER VARIATIONS

**Wessex ModuMax 100/100c** - Single 100 kW unit  
**Wessex ModuMax 100/200c** - Single 200 kW unit.( created by stacking 2 – 100 kW modules vertically ).  
**Wessex ModuMax 100/300c** - Single 300 kW unit.( created by stacking 3 – 100 kW modules vertically ).  
**Wessex ModuMax 120/120c** - Single 120 kW unit.  
**Wessex ModuMax 120/240c** - Single 240 kW unit  
**Wessex ModuMax 120/360c** - Single 360 kW unit  
**Wessex ModuMax 150/150c** - Single 150 kW unit.  
**Wessex ModuMax 150/300c** - Single 300 kW unit.  
**Wessex ModuMax 150/450c** - Single 450 kW unit.  
**Wessex ModuMax 200/200c** - Single 200 kW unit.  
**Wessex ModuMax 200/400c** - Single 400 kW unit  
**Wessex ModuMax 200/600c** - Single 600 kW unit.  
**Wessex ModuMax 250/250c** - Single 250 kW unit.  
**Wessex ModuMax 250/500c** - Single 500 kW unit.  
**Wessex ModuMax 250/750c** - Single 750 kW unit .

1.7 The fully assembled unit is supplied covered with a protective sleeve. The flue assemblies for the stacked models are supplied in a separate pack.

1.8 Each Wessex ModuMax module is supplied with vfc contact outputs for Normal Run and General Fault outputs, and 0~10v analogue control input compatibility.

### 1.9 Options

1.9.1 Optional reverse return header kits are available for models:

100/200c, 100/300c, 120/240c, 120/360c, 150/300c, 150/450c, 200/400c, 200/600c, 250/500c & 250/750c.

These kits are free-standing allowing installation to the system prior to installing the boiler and can incorporate all necessary valves, inter connecting pipework, and flexible flow and return connections. Refer to individual kit instructions for details.

#### 1.9.2 Controls peripherals

The LMU boiler management system has the potential to accept the following control options:

##### 1.9.2.1 External sensor

Allows direct weather compensation on an individual boiler. Not to be used for multiple boiler systems.

##### 1.9.2.2 Clip in module (LPB Bus)

Allows communication with multiple boilers under the control of a 'Merley' cascade control unit.  
(available from Hamworthy Heating Ltd)

##### 1.9.2.3 RVS cascade control

Allows cascade management of up to 12 boilers, and interface with a BMS system.



## 2.0 SUPPLY AND DELIVERY

Your boiler is despatched to site as a pre-assembled and tested unit. Each boiler is delivered by a tail lift vehicle and lowered to ground level. It is the installers responsibility to convey the boiler to the plantroom.



**Figure 2.1 - Boiler Delivery**

The base of each boiler is specially designed to accept a standard pallet truck. This allows the boiler to be manoeuvred into position without any pallets to remove. Additionally the boiler is designed to pass through a standard doorway where access is restricted.



**Figure 2.2 - Boiler Positioning**

**NOTE:** The boiler is packaged with cardboard corner protection and shrunk wrapped for basic protection during handling. However, when manoeuvring the boiler care must be taken to avoid damage to the casing.

The boiler must be kept upright during handling. Care must be exercised to avoid toppling the boiler as this will result in damage.

Each 2 and 3 high stacked Wessex ModuMax model is supplied with a flue collector manifold. This is separately packaged in a dedicated cardboard box. Single Wessex ModuMax boilers do not have an additional flue collector manifold.

**NOTE:** Care must be taken as impacts will cause damage to the flue collector manifold.

**Figure 2.3 - Boiler Packaged Dimensions**

Model	Depth	Width	Height	Weight
Wessex ModuMax 100/100c & 120/120c	1200mm	780mm	900mm	180kg
Wessex ModuMax 100/200c & 120/240c	1200mm	780mm	1420mm	355kg
Wessex ModuMax 100/300c & 120/360c	1200mm	780mm	1980mm	540kg
Flue Manifold Kit 100c & 120c	260 mm	260 mm	600mm	5kg
Wessex ModuMax 100/200c Wessex ModuMax 120/240c	x2			10kg
Wessex ModuMax 100/300c Wessex ModuMax 120/360c	x3			15kg
Wessex ModuMax 150/150c	1200mm	780mm	900mm	226kg
Wessex ModuMax 150/300c	1200mm	780mm	1420mm	452kg
Wessex ModuMax 150/450c	1200mm	780mm	1980mm	678kg
Wessex ModuMax 200/200c	1200mm	780mm	900mm	226kg
Wessex ModuMax 200/400c	1200mm	780mm	1420mm	452kg
Wessex ModuMax 200/600c	1200mm	780mm	1980mm	678kg
Wessex ModuMax 250/250c	1200mm	780mm	900mm	226kg
Wessex ModuMax 250/500c	1200mm	780mm	1420mm	452kg
Wessex ModuMax 250/750c	1200mm	780mm	1980mm	678kg
Flue Manifold Kit 150c/200c/250c	350mm	350mm	600mm	6.5kg
Wessex ModuMax 150/300c Wessex ModuMax 200/400c Wessex ModuMax 250/500c	x2			13kg
Wessex ModuMax 150/450c Wessex ModuMax 200/600c Wessex ModuMax 250/750c	x3			19kg

**Delivery Verification**

When taking delivery please ensure that you have received the correct number of boilers and flue collector manifold to fulfil your order. If any item is missing please contact our after sales service team. Please provide details of your order number and contract number as well as a detailed description of the missing item.

## Reverse Return Header Sets

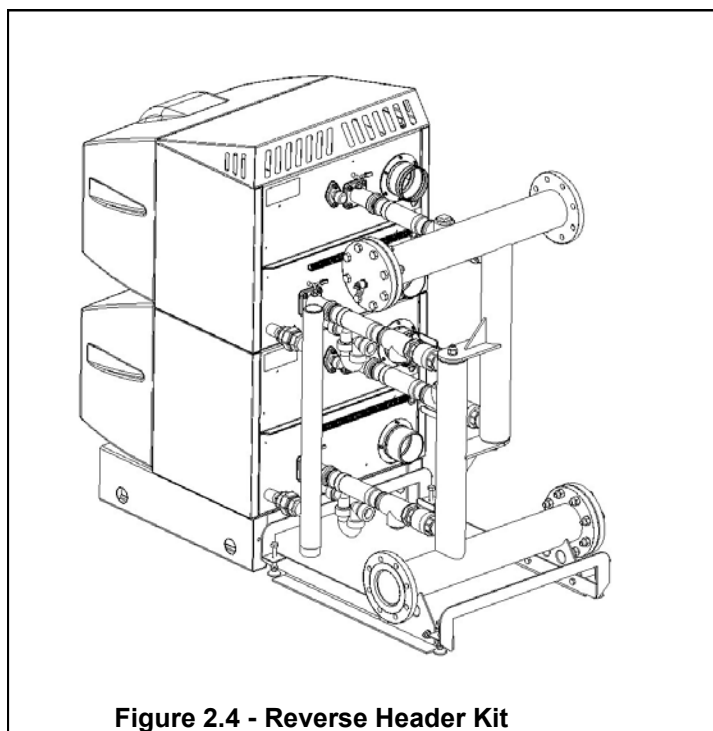

**Figure 2.4 - Reverse Header Kit**

Where reverse return header sets are used these are packaged separately from the boilers. The packaging for each header set is defined in the table below. Ancillary items such as isolation valves and flexible boiler connectors are packaged in a cardboard box on the same pallet. The whole is shrink wrapped for security and basic protection.

Model	Depth	Width	Height	Weight
Wessex ModuMax 100/200c, 120/240c.	1200mm	800mm	1490mm	120Kg
Wessex ModuMax 100/300c, 120/360c.	1200mm	800mm	2040mm	160kg
Wessex ModuMax 150/300c, 200/400c, 250/500c.	1200mm	800mm	1520mm	192kg
Wessex ModuMax 150/450c, 200/600c, 250/750c.	1200mm	800mm	2060mm	233kg

**Figure 2.5 - Header Kit Packaged Dimensions**

**3.0 SIZE AND SPACE REQUIREMENTS**

3.1 The Wessex ModuMax Series boiler range has been designed to utilise minimum floor space by stacking boiler modules, therefore it is important the plantroom has sufficient ceiling height to allow for installation and connection to the flue system.

Also important is allowance for sufficient access at sides and rear of boiler for flue and pipework connections. See Figure 3.1.1 below.

**Figure 3.1.1 - Dimensions and Clearances 100c & 120c**

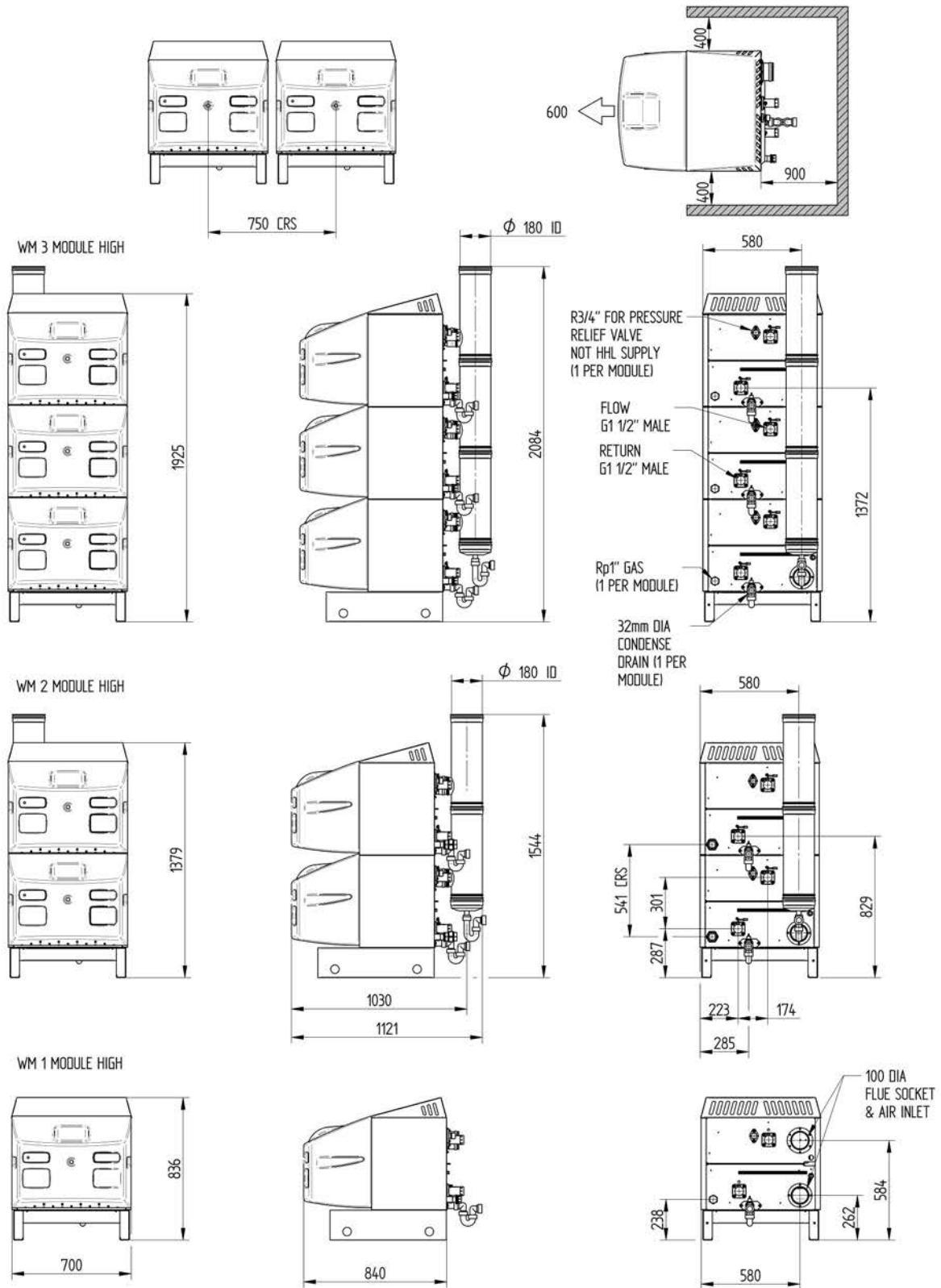
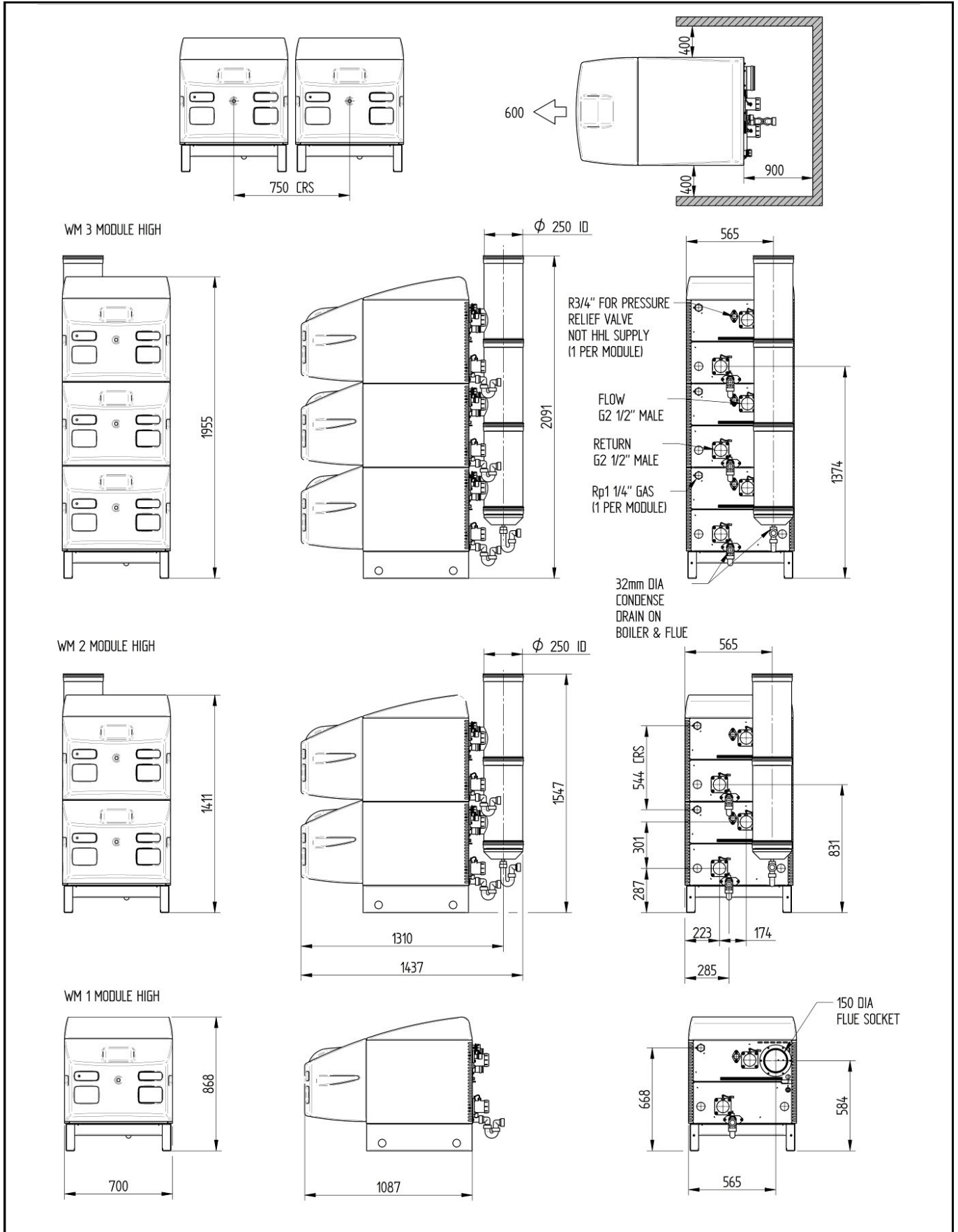

Figure 3.1.2 - Dimensions and Clearances 150c/200c/250c



3.2.1 The Hamworthy Heating Ltd water manifold kit is designed to provide a compact solution for connecting the boilers to the gas supply and flow and return water connections. There are two kits specific to individual models. (Refer to the Installer's Guide 500005117 for specific details on the manifold kit, suitable for 100c & 120c models)

Safety Valve: When using this kit it is important that each boiler module is fitted with an individual safety valve using the connection provided on the back of each boiler. This item is not supplied with the boiler.

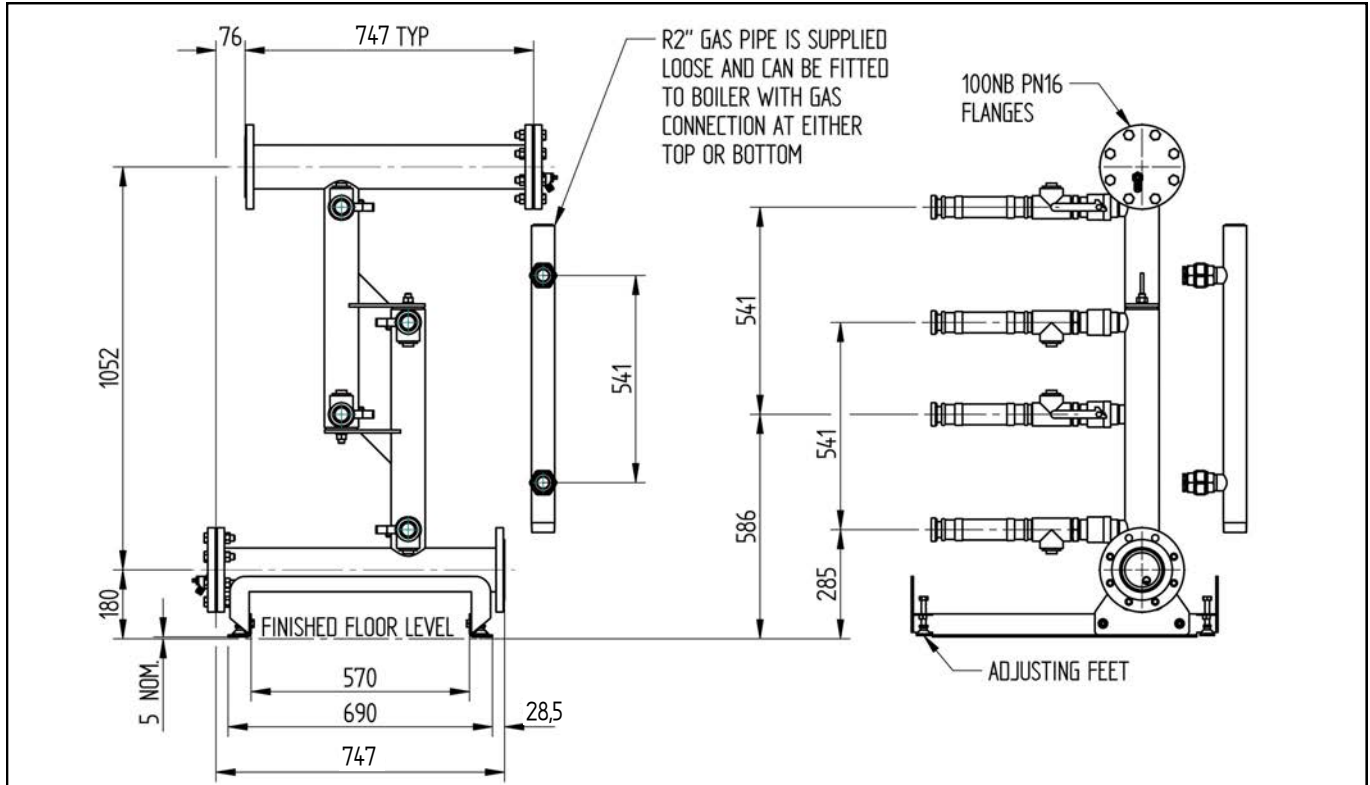

Figure 3.2.1.1 – Manifold Dimensions for ModuMax 100/200c & 120/240c

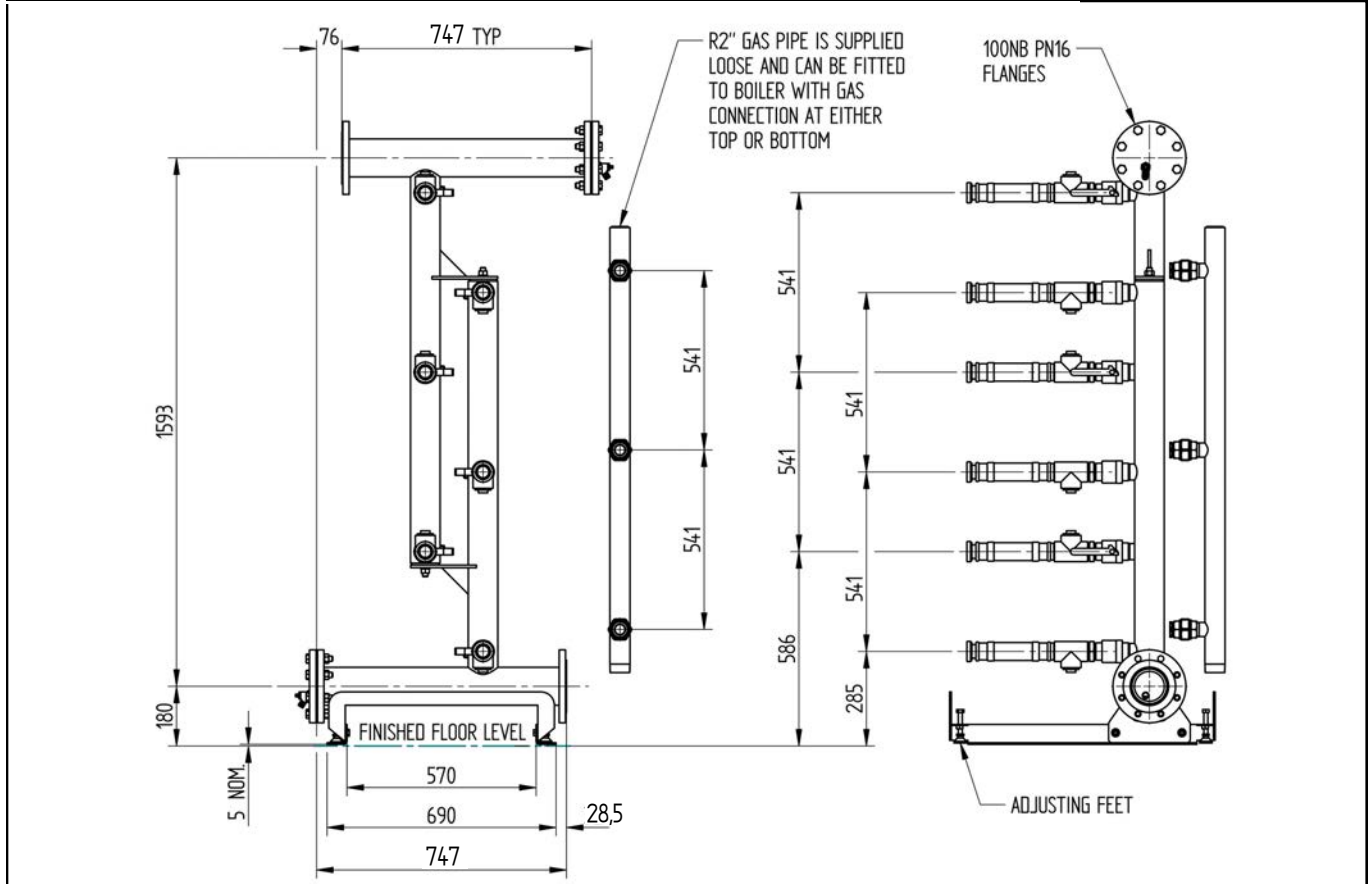
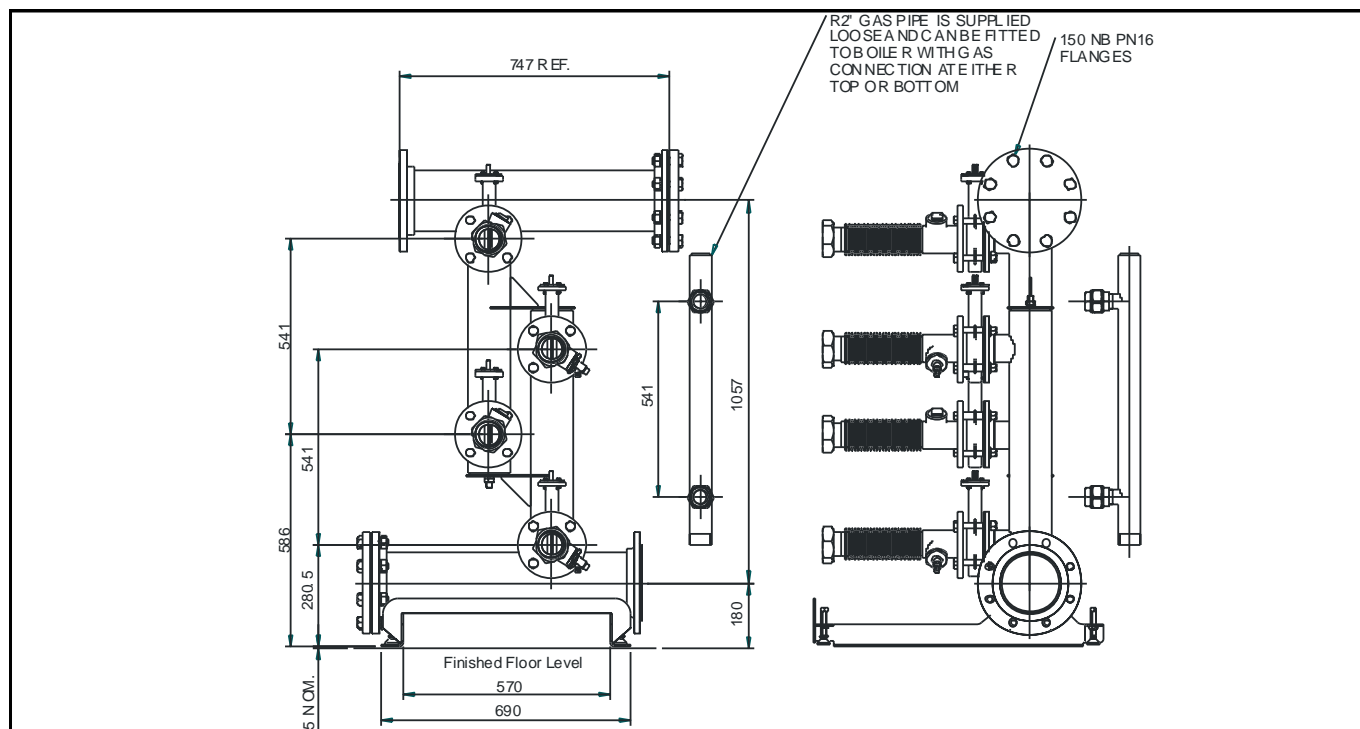

Figure 3.2.1.2 – Manifold Dimensions for ModuMax 100/300c & 120/360c

3.2.2 The Hamworthy Heating Ltd water manifold kit is designed to provide a compact solution for connecting the boilers to the gas supply and flow and return water connections. There are two kits specific to individual models. (Refer to the Installer's Guide 500005119 for specific details on the manifold kit, suitable for 150c/200c/250c models)

Safety Valve: When using this kit it is important that each boiler module is fitted with an individual safety valve using the connection provided on the back of each boiler. This item is not supplied with the boiler.



**Figure 3.2.2.1 – Manifold Dimensions for ModuMax 150/300c, 200/400c, 250/500c**

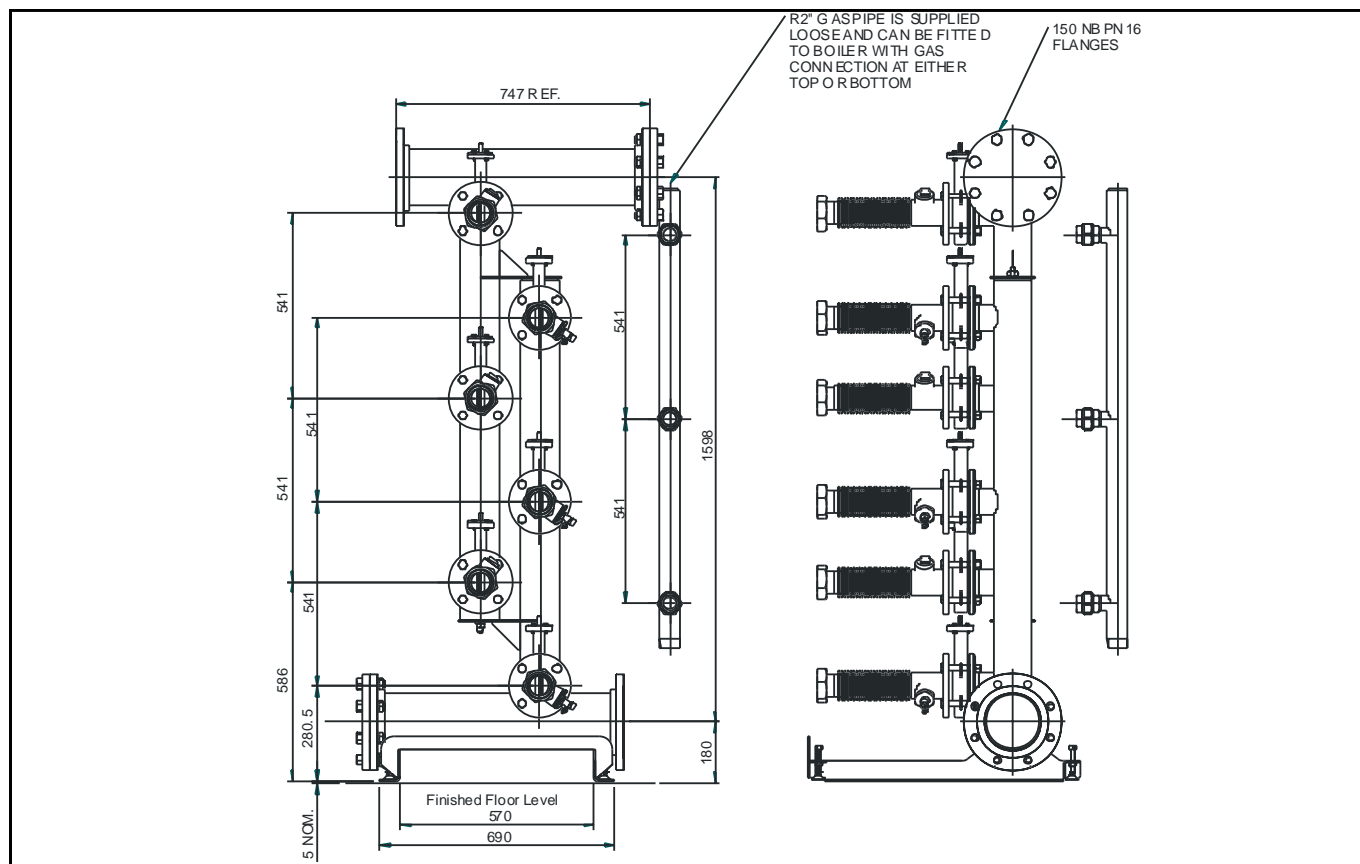

**Figure 3.2.2.2 – Manifold Dimensions for ModuMax 150/450c, 200/600c, 250/750c**

## 4.0 SITE LOCATION AND PREPARATION

### 4.1 Site Location.

- The floor or plinth for the boilers and water manifold kit must be both flat and level to ensure correct alignment of fittings and connections.
- The floor or plinth must be sufficiently strong to support the weight of both the boilers and manifold kit where used.
- The floor or plinth must be fireproof in accordance with BS 6644.
- The plantroom must have sufficient space for installation of boilers, manifold kits, pipework, pumps controls, flues ventilation, access and servicing and other items of plant.

### 4.2 Gas Supply.

- Gas supply pipes must be in accordance with BS 6891 or IGE/UP/2
- Gas supply connections to the boiler must not be smaller than the connection on the boiler - Rp1" (100c & 120c) & Rp1 1/4" (150c/200c/250c)
- Gas installation must be soundness tested to BS 6891 or IGE/UP/1 & IGE/UP/1A.
- Gas installation must be purged to BS 6891 or IGE/UP/1 & IGE/UP/1A.
- Boiler inlet gas pressure; nominal 20mbar (minimum 17.5mbar) for Natural Gas or nominal 37 - 50mbar (minimum 30mbar) for LPG dynamic at the connection to the boiler.
- Boiler house gas isolation valve must be clearly identified and installed close to the entrance / exit.

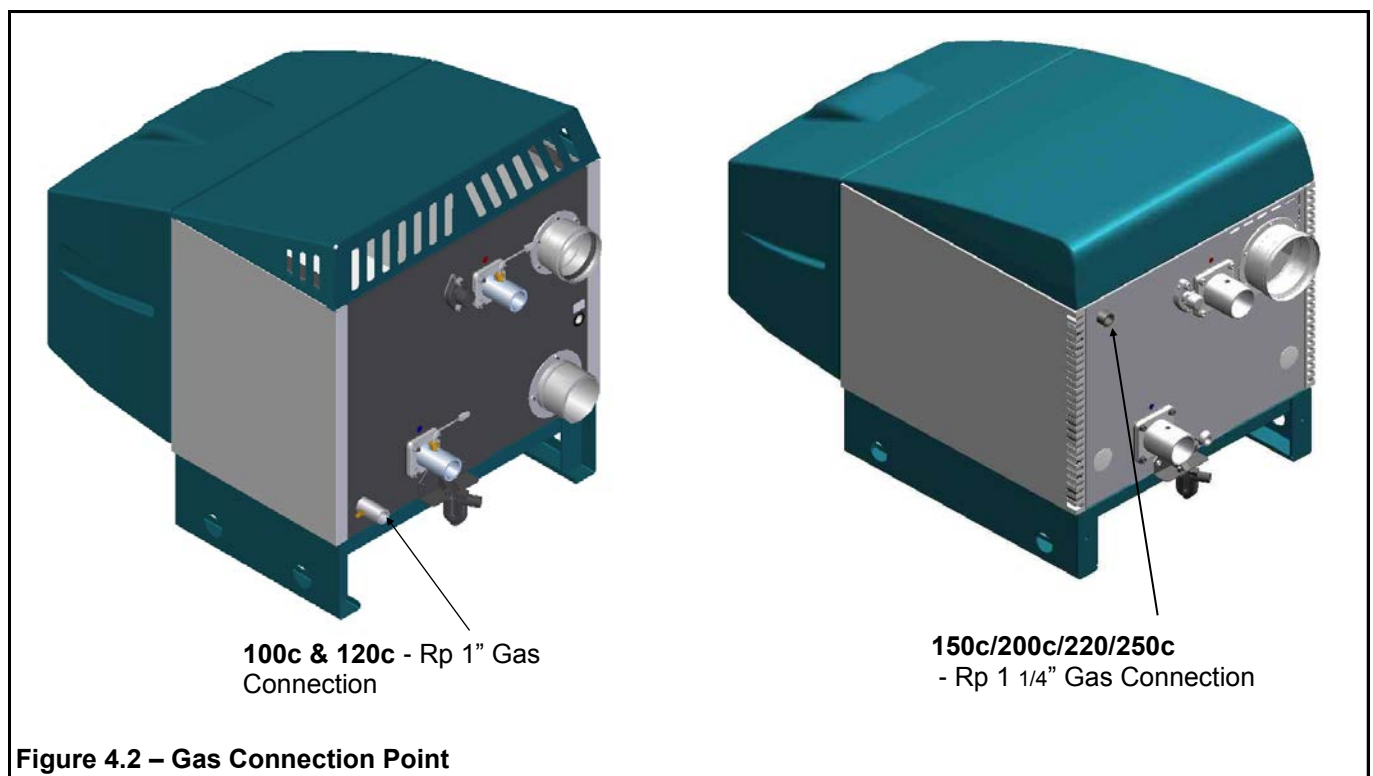



### 4.3 Flueing

- Flue termination, routing and construction must comply with the requirements of the Clean Air Act 1956, BS 6644 BS 5440 and IGE/UP/10.
- The Wessex ModuMax 100c & 120c boilers can be installed as a room sealed boiler using the flue components supplied by Hamworthy Heating. The Wessex ModuMax 150c/200c/250c boilers are intended for connection to a traditional chimney system- refer to Appendix C for installation details.
- Wessex ModuMax 2 and 3 high stacked models must use the headers provided with the boiler prior to any connection to the flue system. A condense trap (32mm dia.) is supplied with the flue header.
- Any flue must be self supporting and separable from the boiler for servicing requirements.
- The maximum number of modules firing into a common chimney is 9. For larger installations refer to HHL Technical
- Due to the low flue gas temperature, 50°C (condensing) - 135 °C (non-condensing), condensation will occur in the flue, flue materials must be non-corrosive and utilise fully sealing joints.
- Flue construction is recommended of a twin wall, insulated type to maintain buoyancy within the flue.
- Adequate facilities must be provided for draining the flue condensation.
- Horizontal flue runs must be kept as short as possible and be inclined at minimum 2° towards the terminal.
- The flue system must be designed acknowledging that there is a positive pressure generated by the boiler combustion fan. Refer to Appendix C.
- The flue system must be designed to limit the max. suction (cold) to 30Pa negative, measured at the connection to the boiler. If the suction is greater than 30Pa, refer to HHL technical.  
This condition must then be checked hot and with all boilers firing, the max. pressure at the connection to the boiler should be 150Pa positive.  
In the event that the flue system when hot does generate a suction, the max. suction is 100Pa.
- Any stabiliser fitted must be in or close to the vertical chimney.
- Fan dilution - the design must provide for the use of balancing and trim dampers, and their location and operation must be such that the constraints detailed above can be met. Care must be taken to ensure that the fan performance is matched to deliver the appropriate dilution, whilst ensuring that excessive suction is not applied to the boilers. If in doubt, refer to HHL Technical.
- Fan assist - the use of fan assist must only be a last resort, as the boilers have sufficient fan performance to drive the system. If in doubt, refer to HHL Technical.

Flueing cont....

- **Connecting flue systems may be smaller in internal diameter than the boiler connection and must be designed to deliver the necessary condition at the connection to the boiler. Refer to Hamworthy Heating Technical Dept for assistance.**

#### 4.4 Water Supply

- **Feed and Expansion tanks to comply with static height requirements of HSE document PM5.**
- **Cold feed and open vent pipes to comply with requirements of BS 6644.**
- **Pressurised system to comply with BS 7074.**
- **It is recommended that the system pipework is flushed twice before water treatment.**
- **In hard water areas (>180mg CaCO<sub>3</sub>/litre) precautions such as water treatment are strongly recommended to prevent the build up of sludge and scale and also to control the system water pH to between 7.0 & 8.0.**
- **Leaks in the system pipework should be fixed to prevent dilution of water treatment.**
- **Maximum working water pressure is 10bar.**
- **For minimum water pressure see Appendix 'E' - Water Data**

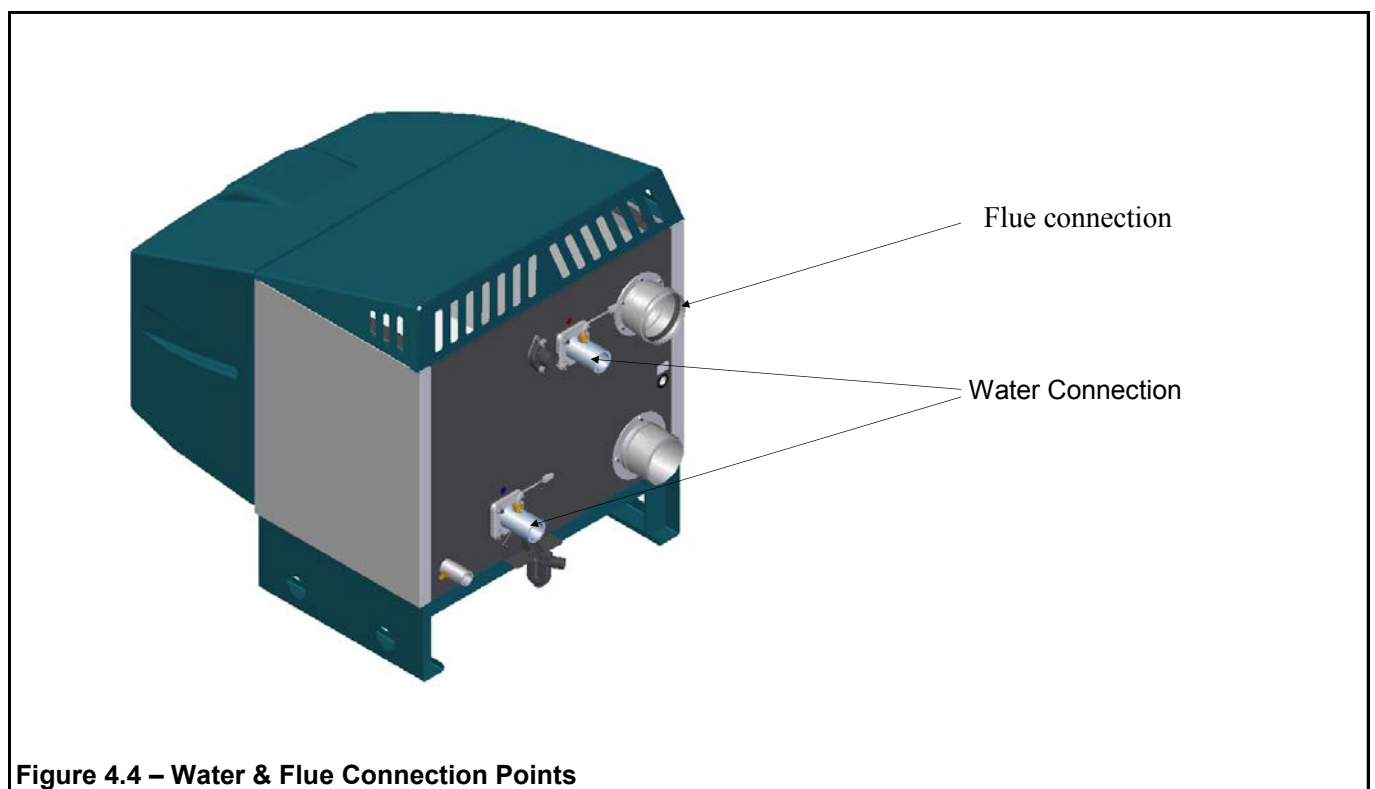
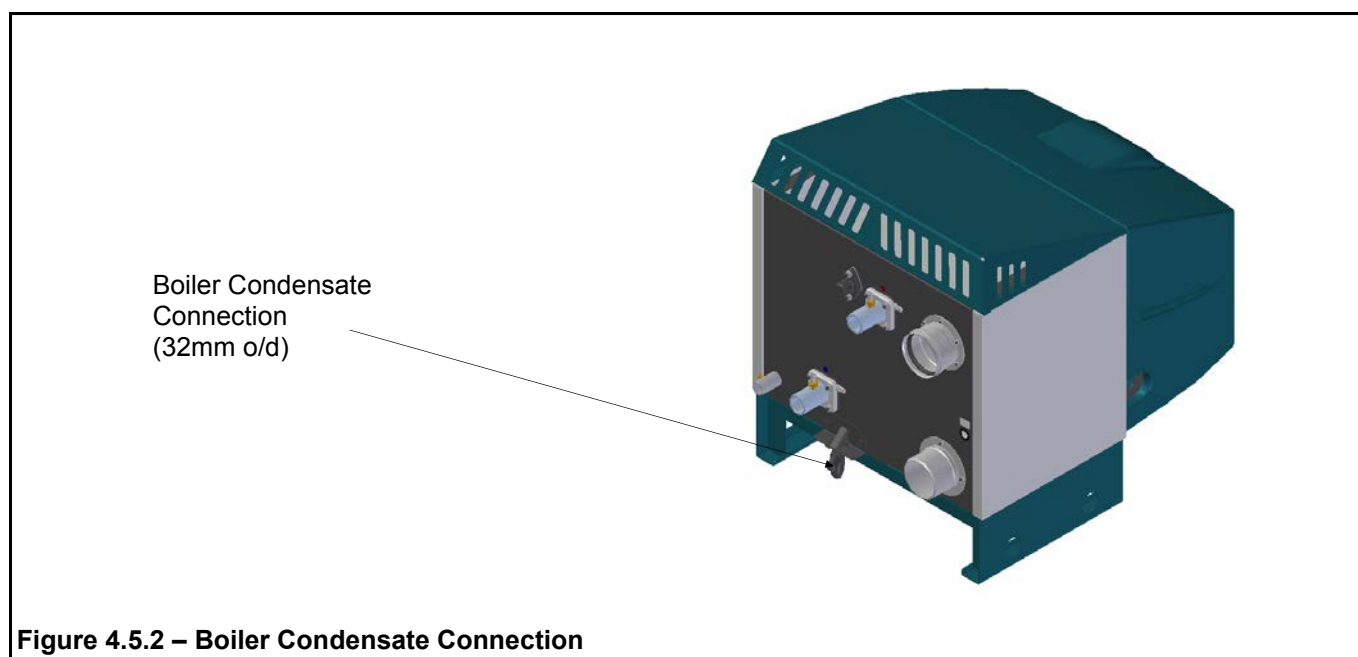
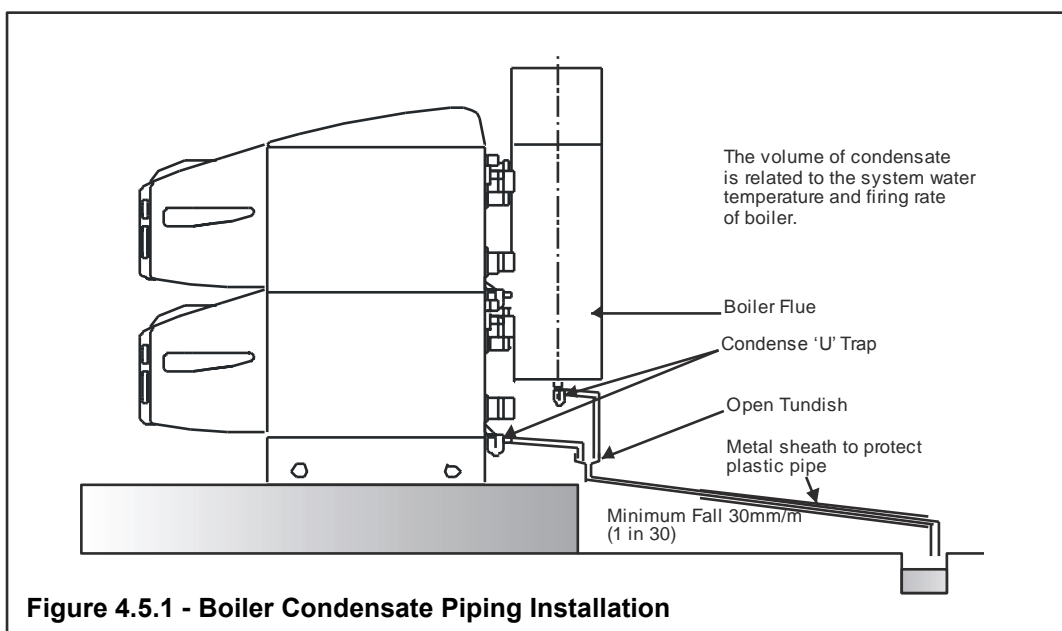

Figure 4.4 – Water & Flue Connection Points

#### 4.5 Condensate Connections

- Provision must be made for removal of condensate from the boiler and flue system.
- Condense is mildly acidic, typically pH3 - pH5.
- Condense pipework must be non-corrosive and not copper. Hamworthy recommend 32mm dia. Plastic waste pipe.
- Condense may be discharged to a standard drain subject to National or Local regulations.
- Location of condensate pipework should prevent freezing within tundishes, traps and pipework.
- The connection to the boiler condensate drain accepts a straight push-fit coupling for 32mm i.d. plastic waste pipe.



## 4.6 ELECTRICAL SUPPLY

**WARNING! THIS APPLIANCE MUST BE EARTHED IN ACCORDANCE WITH IEE REGULATIONS**

- Boiler electrical supplies must not be switched by a time clock.
- Boilers are suitable for 230Volt, 50Hz supply.
- External fuses should be rated for 10 amps
- Wiring must be completed in heat resistant cable size 1.0mm<sup>2</sup> csa.
- Each module should have individual means of isolation.
- Electrical isolators must facilitate complete electrical isolation.
- Electrical isolators must have contact separation of minimum 3mm in all poles.
- Electrical isolators must be installed in readily accessible locations.
- Electrical supplies to boiler modules should only serve the boiler.
- Where volt free contacts are used, these too must be individually isolatable.
- Time clock control should be via the boiler modules stop/start circuit (24V DC).

**ADDITIONAL INFORMATION REGARDING ELECTRICAL SUPPLIES IS GIVEN IN BS EN60335, Part 1.**

**NOTE: The appliance must be isolated from the electrical supply if electric arc welding is carried out on connecting pipework.**

**FOR DETAILED WIRING INSTRUCTIONS SEE SECTION 5.3 & 9.3**

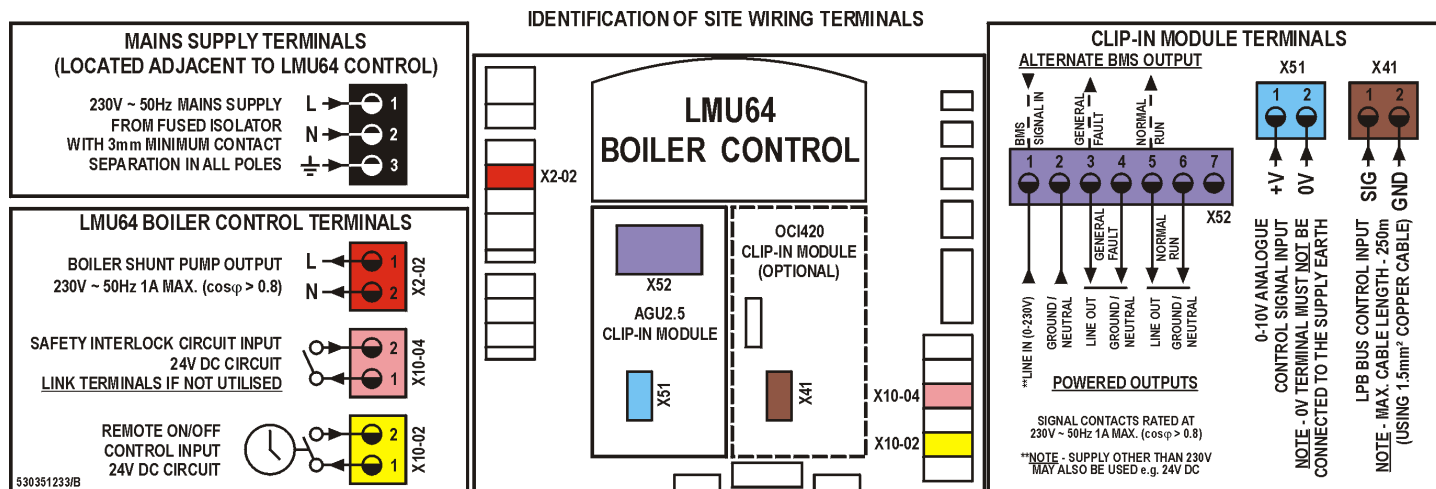

Figure 4.6 - Siemens Electrical Connections

## 5.0 BOILER ASSEMBLY

### General

Boilers are despatched to site as fully assembled units. The flue collector box (stacked models only) and pipework manifold set (where applicable) are the only items that will need assembling on site.

During assembly it is important to take care to prevent damage to the boiler casing.

Boiler positioning must allow the minimum clearances detailed in Section 3.0 to facilitate access for flue and pipework connections as well as maintenance.

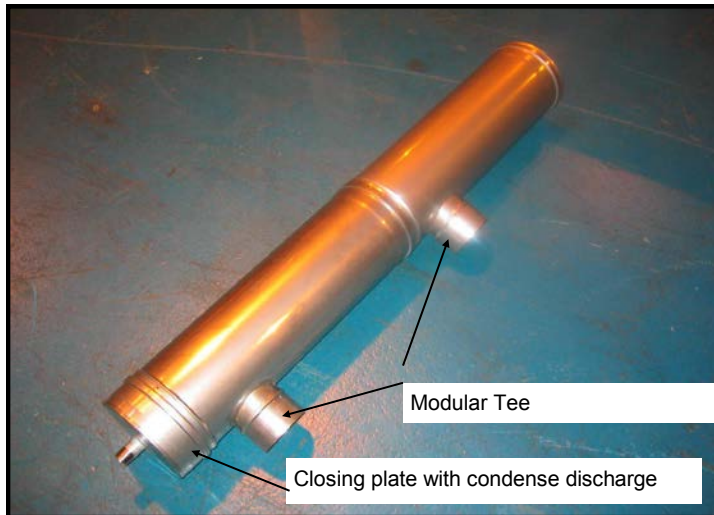

**Figure 5.1 - Flue Collector Box Assembly**

1. With the boiler in its desired location, loosely engage the flue collector ducts into each other and position such that the spigots will fit into the respective flue sockets at the rear of the boiler.

In assembling the flue ducts, it is advisable to lubricate the seal located in the socket fittings to enable easy movement and adjustment.

2. Fit and secure the bottom closing plate to the base of the duct assembly.

Do not fit the flue collector at this stage as it may restrict access to the other connections.

**Note:** Should modules be arranged in banks of 2 or 3 high, adjacent to each other, it is advisable to fit the water and flue connections to each individual bank prior to fitting the connections to the adjacent bank(s).

### 5.2 Water Connections:

The following connections are provided on each boiler module;

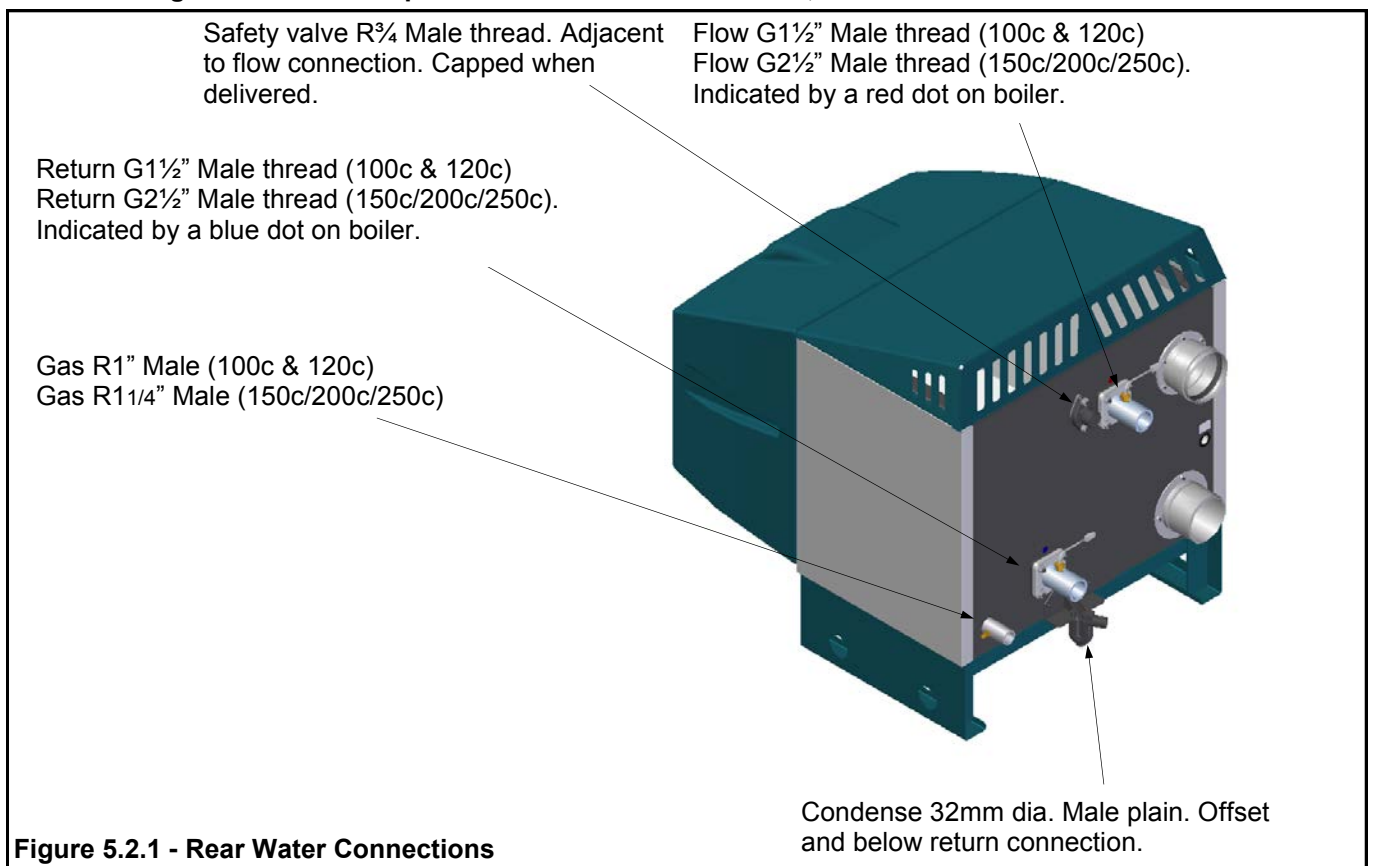

**Figure 5.2.1 - Rear Water Connections**

**Figure 5.2.2 - Flue Header Connection**

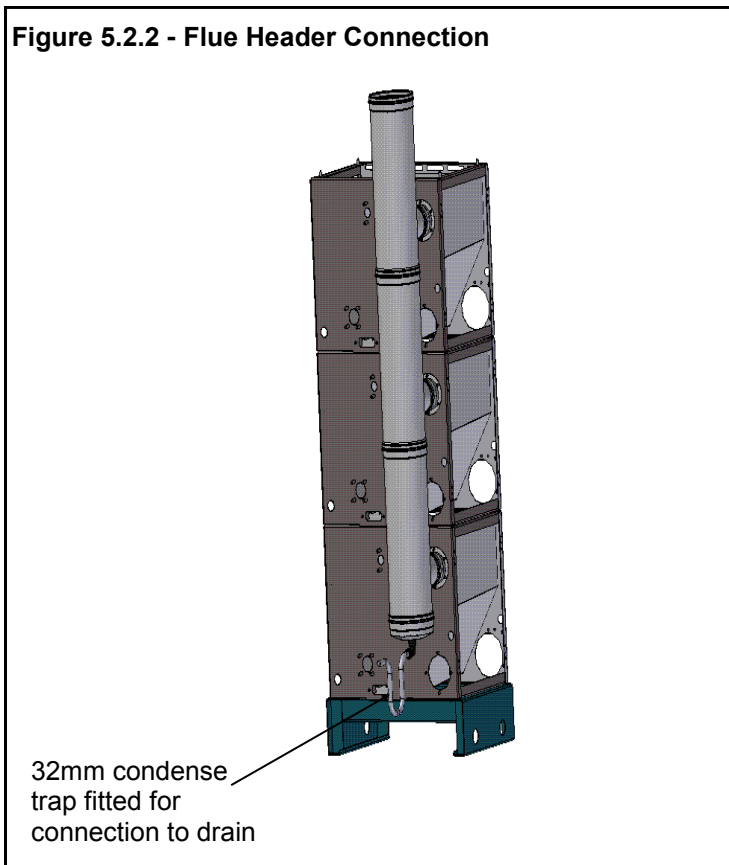

Prior to fitting the flue collector assembly, check all water and gas connections for soundness.

Lubricate the seals on the boiler flue spigot to enable easy movement and adjustment.

Adjust and fit the assembled flue collector box to the boiler flue spigots and fit the condense drain discharge pipe to the base of the flue using the fitting supplied.

Connecting pipework must be self-supporting to avoid stress on the boiler connections. Local unions are recommended in the pipework to facilitate future servicing requirements.

### **Open Vented Systems**

Boilers must not be capable of isolation from the vent pipe. Valves between boiler and vent pipe to be three way type such that when boiler is isolated from vent pipe it is open to atmosphere. Safety valves should be mounted on the boiler using the connection provided.

### **Sealed Systems**

Boilers must not be capable of isolation from the safety valve. Valves between boiler and safety valve to be three way type such that when boiler is isolated from vent pipe it is open to atmosphere. Hamworthy Heating Ltd recommend using the safety valve connection provided on the boiler.

Where using Hamworthy Heating Ltd pipework kits, assembly of these is detailed in Operation and Maintenance manual 500005117 (100c & 120c), 500005119 (150c/200c/250c) supplied with kit.

### **5.3 Electrical Connections:**

The following electrical connections are provided on each module.

- Supply: Live, Neutral and Earth. See Section 4.5 for details.
- Supply Input for Boiler Fault and Normal Run Signals
- Boiler General Fault Alarm Signal Output
- Boiler Normal Run Signal Output
- 0-10v Analogue Control Signal Input
- Remote on/off Control Input
- Boiler Shunt Pump Output
- Safety Interlock Circuit Input
- Optional LPB Bus for use with RVS cascade control

## **6.0 PRE-COMMISSIONING**

The following pre-commissioning check must be carried out before the boiler is commissioned.

### **6.1 Gas Supply.**

Ensure that gas installation pipework and meter has been soundness tested and purged to IGE/UP/1 or IGE/UP/1A as appropriate. Test and purge certificates should be available for viewing.

### **6.2 Ventilation**

Ensure that ventilation and air supply to plantroom is correct. Air supply slots in front cover and top panel are clear and open.

### **6.3 Pipework, Valves and Pump**

Ensure that;

- Pipework and valve arrangement is installed to Hamworthy Heating recommendations.
- Circulating system is full of water, vented and pressurised appropriately and the water quality checked.
- Circulation pump is fitted, working and interlocked where required.
- Pipework connections to boiler are fitted correctly.
- All necessary isolation valves are open.
- Safety valve is correctly sized and located.
- Condense connections on boiler and flue are connected and piped to drain.
- Heat load is available.

### **6.4 Flue**

Ensure that;

- Flue system is correctly designed and installed to suit boilers.
- Flue passages to chimney are clear.

### **6.5 Electrical**

Ensure that;

- Electrical connections are correct and isolatable.
- External controls are operational.

**WARNING: WHEN THE FRONT COVER IS REMOVED AND THE BOILER IS OPERATIONAL, CARE MUST BE TAKEN WITH ELECTRICAL COMPONENTS AND ACCESS TO PRIMARY INSULATION.**

## 7.0 Checks Prior to Lighting

**IMPORTANT: BEFORE PROCEEDING ENSURE THAT THE PRE-COMMISSIONING CHECKS ON PAGE 14 HAVE BEEN CARRIED OUT AND THE RESULTS SATISFACTORY.**

### 7.1 Boiler Gas System Leak Check

Pull off front cover moulding & ensure that the appliance manual gas service valve is in the **OFF** position. Although the boiler receives a gas leak check and gas train component integrity check prior to leaving the factory, transport and installation may have caused disturbance to unions, fittings and gas valve assemblies etc.

A procedure guide is given below. Care must be taken not to allow leak detection fluid (if used) on or near any electrical parts or connections.

**NOTE: When testing 2 or 3 high stacked appliances the test detailed below must be carried out on each module.**

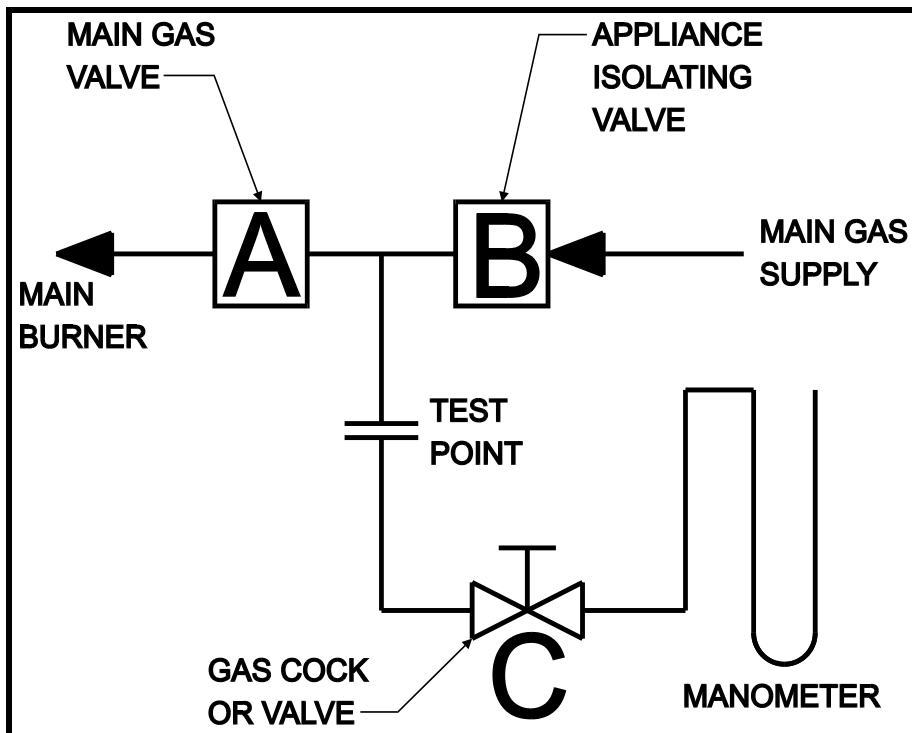

Figure 7.1 - Gas System Leak Check Diagram

**Note:-**

Main Gas Supply Pressures are as follows;  
Natural Gas - 20mbar, LPG - 37mbar.

#### TO CHECK B

- 1) Turn off the electrical power and gas to the appliance.
- 2) Connect the manometer assembly to test point (Fitted on the inlet to the gas valve).
- 3) With A and B closed open C and monitor manometer over a 2 minute period, a rise indicates a leak on valve B.

#### TO CHECK A

- 1) Open C.
- 2) Open B to produce the mains gas supply pressure between A and B.
- 3) Close B.
- 4) System may be considered sound if over a period of 2 minutes any drop in pressure is less than 0.5 mbar (0.2" wg.).

**Note:-** Allow a manometer stabilisation period of approximately 1 minute before each 2 minute check period. Following soundness tests close valve B and remove manometer connections and tighten test points.



7.2 Refer to Appendix A, Gas Data Tables, for maximum inlet pressure for normal operation.

**The Following checks must be made prior to lighting the boiler;**

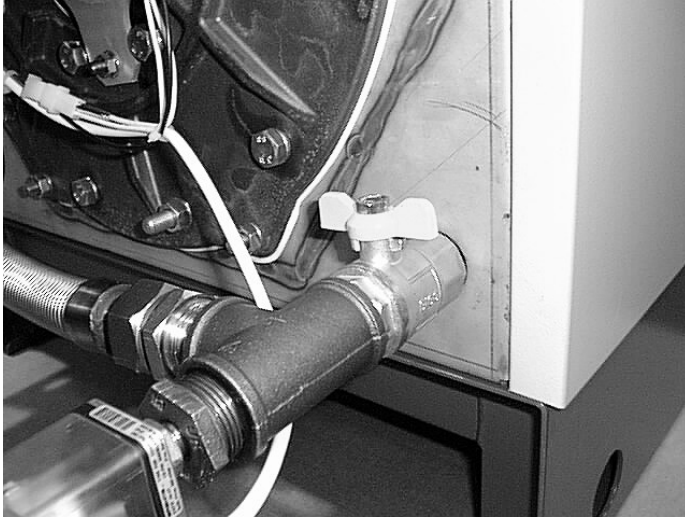

**Figure 7.2.1 - Gas Valve (100c & 120c shown)**

1. Ensure that the gas supply is connected, but the boiler module gas service valve(s) are **closed**, any unions or fittings are correctly tightened and test points are **closed**.

2. Ensure the electrical mains supply is correctly connected but the boiler module isolator(s) are **switched off**. Check all wiring loom connections such as fan or gas valve are correct and secure. Reset and test the operation of the temperature limiter by firmly pressing the reset button (on controls fascia), removing the clip and bulb from the pocket in the front of the heat exchanger, and carefully applying a heat source to the bulb. The reset button should operate. If satisfactory, refit the bulb in the pocket and secure with the clip. Ensure that all thermostat bulbs are fully inserted into the pocket. The flow and return sensor bulbs are located at the rear of the boiler in the flow and return pipes.

3. Check setting of both temperature limiter and control thermostat. The temperature limiter must be set at 95°C maximum. This can be achieved by unscrewing the plastic cover (if fitted), unscrewing the shaft securing nut and withdrawing the limiter rearwards from controls housing. Adjust if required and refit in reverse order to that above.

The control thermostat is set using the button (2) on the fascia as detailed in **section 8.2.5 - Controls Operation**.

4. The flame ionisation signal generated whilst the boiler is firing, can be viewed directly from the display by accessing information level C1. The value is set to read dc  $\mu$ A. Refer to **section 8.2.1.2 - Controls Operation**.

5. To ensure correct ignition of the boiler it is recommended to check the resistance of the hot surface igniter. This should be checked cold, using a suitable ohmmeter, by disconnecting the igniter from the control panel cable and measuring the resistance across the pins of the 2 way connector. The reading should be between 70-100 ohms refer to **figure 7.2.3**

6. Before ignition of the boiler it must be ensured that all parts of the appliance are clean and free from debris. Special attention should be paid to ensuring that the air inlet of the venturi is clean and unobstructed.

7. Ensure the heating system circulation / shunt pump is operational and that the pipework is free of air.

**Figure 7.2.2 - Venturi (150c/200c/250c shown)**



**WARNING: WHEN THE FRONT COVER IS REMOVED AND THE BOILER IS IN OPERATION, IT IS POSSIBLE FOR ARTICLES OF CLOTHING OR LONG HAIR TO BE DRAWN INTO THE VENTURI / FAN.**

## Flame Signal Assessment

8. The flame ionisation signal generated whilst the boiler is firing, can be viewed directly from the display screen. The value is set to read dc  $\mu$ A. Refer to **section 8.2.1.2 - Controls Operation**.

**Figure 7.2.3 - Hot Surface Ignitor Check 150c/ 200c/ 250c**



## 8.0 INITIAL LIGHTING

Only competent persons registered for working on non-domestic gas appliances should attempt the following operations. Before attempting to commission any boiler, ensure that personnel involved are aware of what action is about to be taken.

### 8.1 Carry out the following procedure to fire up the boiler:

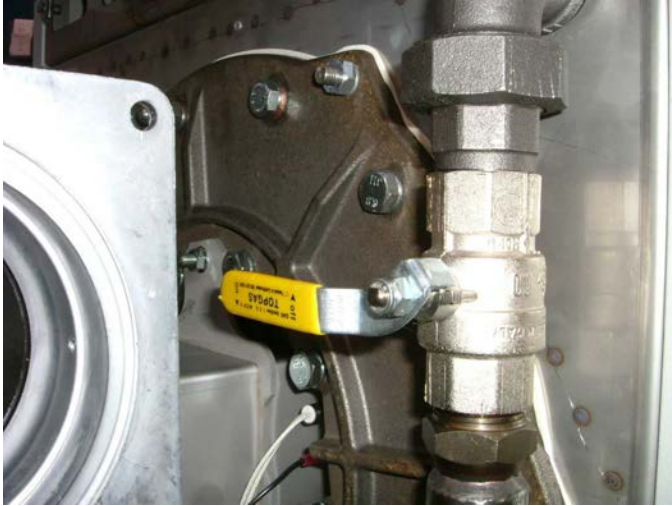

Figure 8.1.1 - Gas Valve

1. Ensure the boiler module gas service valve is closed (Figure 8.1.1)



Figure 8.1.2 - Low Gas Inlet Pressure Switch

2. Check and adjust if necessary the low gas inlet pressure switch located on the side of the boiler gas valve. Setting should be 12.5mbar as indicated on fig. 8.1.2

3. Switch on the electrical supply, and initiate the start up sequence. Refer to **section 8.2.9 & Figure 8.2.1.3 of Controls Operation.**

4. As the gas valve is closed, the low gas pressure switch will prevent the boiler from firing and the error code 'E132' will be displayed on the screen. Refer to **section 8.2.4 of Controls Operation.**

5. If the above procedure occurs correctly, open the gas isolating valve and the fault indication will extinguish.

The boiler will commence its ignition sequence as previously described. This time, when the gas valve is energised the burner will ignite.

6. With the burner firing, the flame signal displayed, should be approximately 15-20 $\mu$ A, but not less than 3 $\mu$ A. Refer to **Figure 8.2.1.2 of Controls Operation.**

- At the end of the ignition proving period, 5 seconds, the hot surface igniter system will be switched off and the indicator on the control fascia extinguished.
- After a period of 15 seconds the fan will alter speed and the burner modulation will be set according to the heat load.
- If after the 5 second flame proving period the flame signal is below 3 $\mu$ A the boiler will shut down and attempt one restart.

**NOTE: THE BOILER IS EQUIPPED WITH A RESTART FACILITY AND WILL ATTEMPT A SECOND IGNITION, DURING WHICH THE ABOVE PROCEDURES WILL BE REPEATED. AT THE END OF THE RESTART PROCEDURE, IF NO FLAME IS DETECTED AFTER THE FLAME PROVING PERIOD, THE BOILER WILL LOCKOUT. THE BOILER WILL NOT OPERATE UNTIL THE LOCKOUT HAS BEEN MANUALLY RESET.**

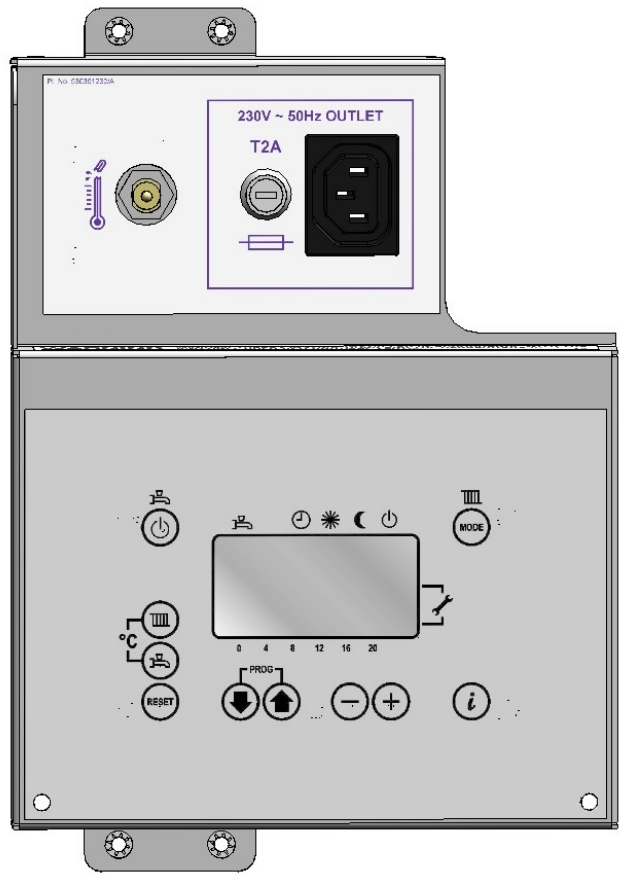

**Figure 8.1.5 - General Overview of Panel Fascia**

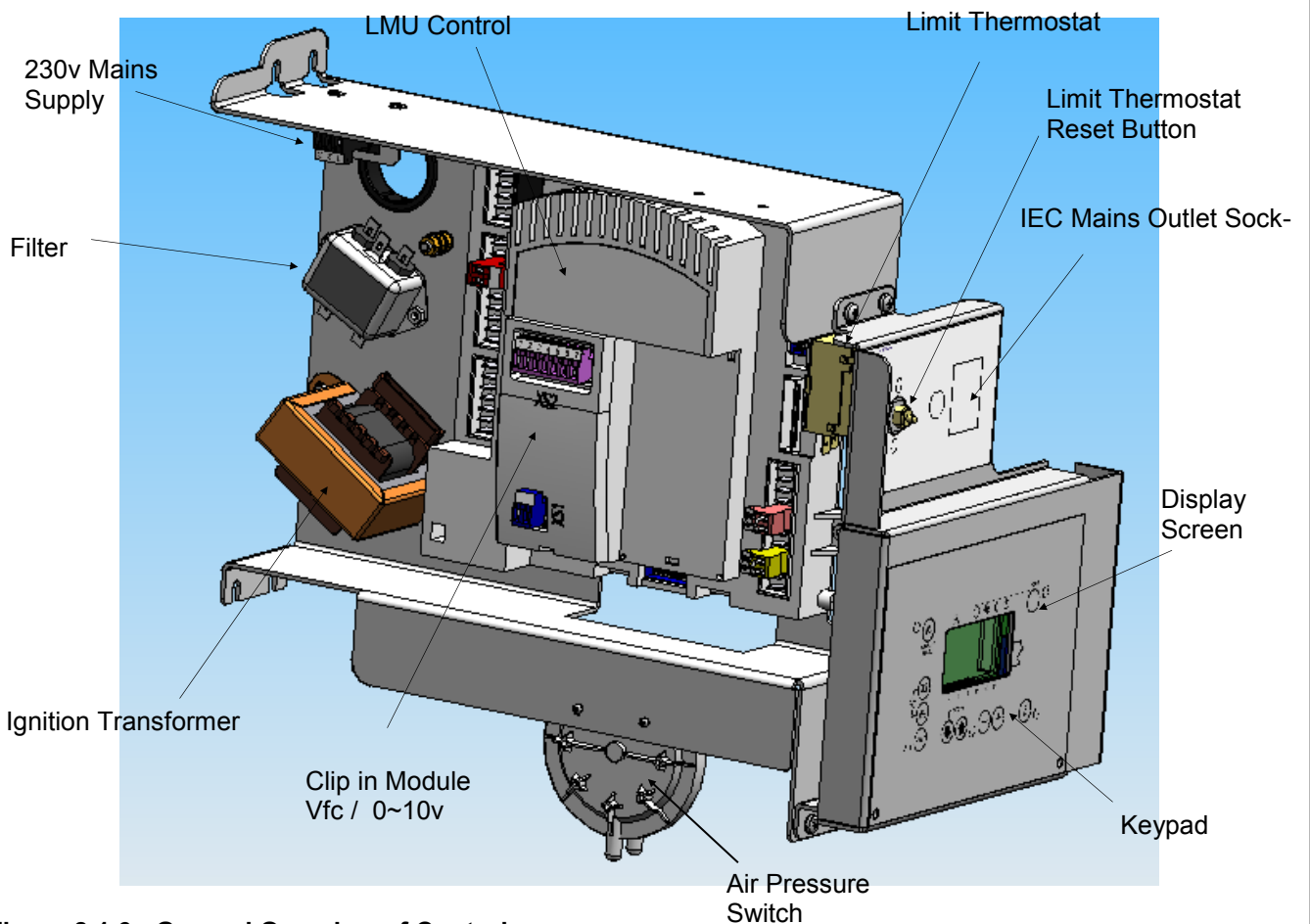

**Figure 8.1.6 - General Overview of Controls**

Boiler Overheat (Safety Temperature Limiter) Rest Button—Visible Through Hole In Label.

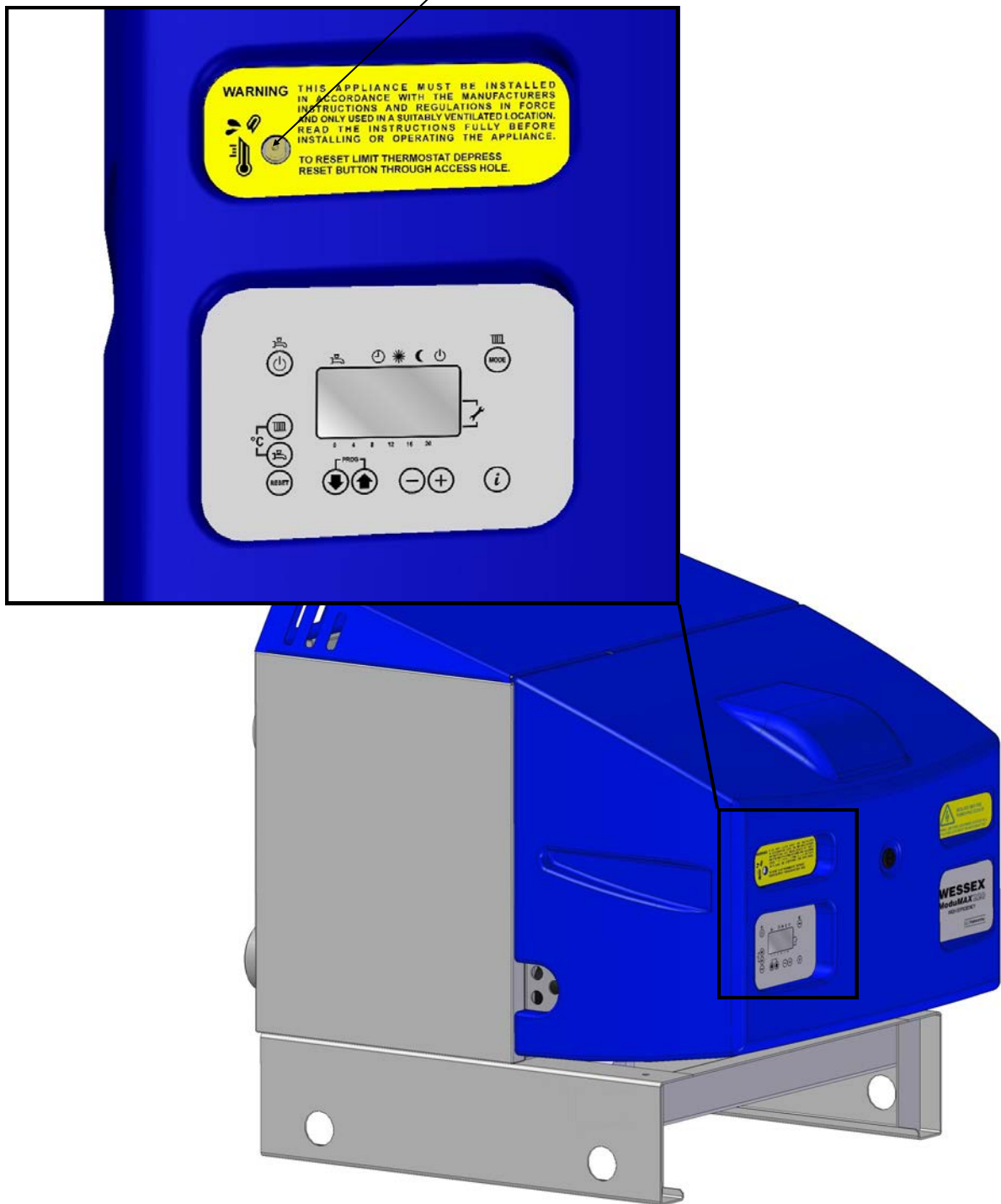

Figure 8.1.7 - Location Of Boiler Overheat (Safety Temperature Limiter) Reset Button

## 8.2 CONTROLS OPERATION

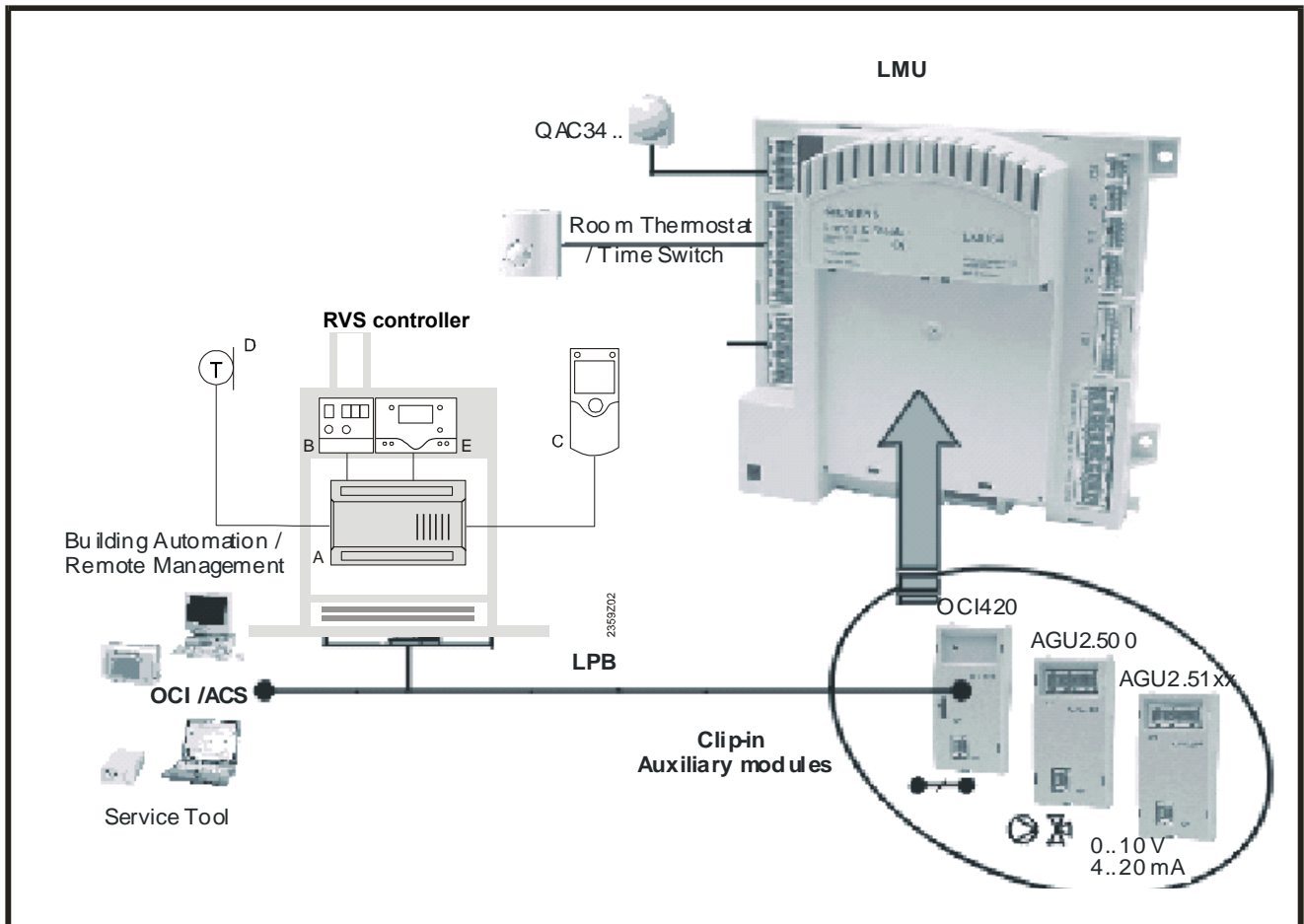

Figure 8.2 - System configuration of boiler control (LMU) & system peripherals

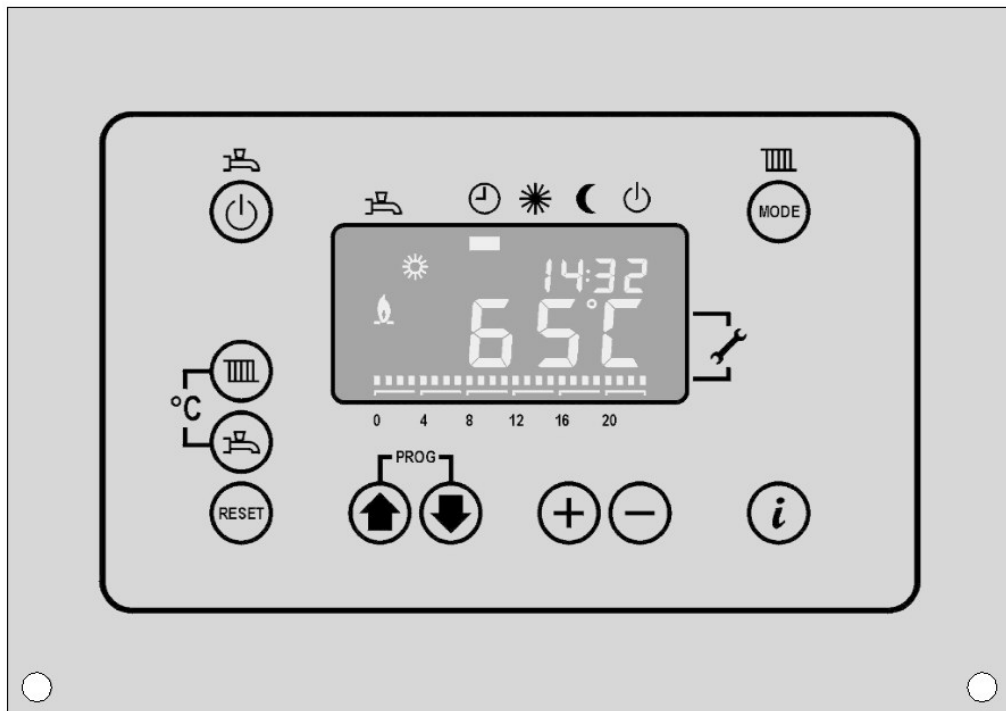













Figure 8.2.1.1 - Fascia Label Legend









**8.2.1 - Info button**  - refer to figure 8.2.1.1

















A change on the information level can be made at any time by pressing the Info button. Additional pushes of the Info button will deliver the following data sequence provided by the information level.

	dhw temperature - <b>not used</b>
	Water Pressure
	
	
	
	Operating phase - refer to section 8.2.15
	Outside temperature
	Error code - refer to section 8.2.14
	Boiler temperature
 	Press one of these buttons to return to the default display

**Extended Info mode** - when on the information level, extended info mode levels b, c & d can be displayed.

Refer to Figure 8.2.2











 	Press both line selection buttons simultaneously for at least 3 seconds
 	Press one of these buttons to select the required display level
 	Press one of these buttons to select the required display value of the level
	Press the Info button to switch to the info display
 	Press one of these buttons to return to the default display

<i>Button</i>	<i>Operation</i>	<i>Function</i>
	Lockout reset	Resetting the LMU
	Enable dhw mode	dhw on/off - <b>not used</b>
	Enable heating circuit mode	selection of operating mode:
		Automatic operation
		Continuous 'Normal' Operation
		Continuous 'Reduced' Operation
		Standby
	Heating circuit temperature setpoint	Adjustment of boiler or room temperature setpoint.
	dhw temperature setpoint	Adjustment of dhw temperature setpoint - <b>not used</b>
 	Line selection (down / up)	Selection of operating parameter
 	Adjustment of settings	Adjustment of parameter settings
	Information	Select information display screens
 	Enable Maintenance mode	Press buttons simultaneously to select

### Figure 8.2.1.2 - Info display parameters

The parameters of groups **b,C** and **d** can only be displayed

Display level	Name of LMU... variable	Description		
<b>General information (Enduser level)</b>				
<b>Temperatures (Service level) <sup>1)</sup></b>				
b 0	DiagnoseCode	LMU...-internal software diagnostic code		
b 1	TkRuec	Boiler return temperature		
b 2	Tbwst2	DHW temperature sensor 2		<b>Not used</b>
b 3	Tabgas	Flue gas temperature		<b>Not used</b>
b 4	TiAussen	Outside temperature		
b 5	TaGem	Composite outside temperature		
b 6	TaGed	Attenuated outside temperature		
b 7	Tvlst	Flow temperature AGU2.500...		
b 8/ b9	Reserved			
<b>Process values (Service level) <sup>2)</sup></b>				
C 0	Reserved			
C 1	IonStrom	Ionization current		
C 2	Geb1_Drehz	Fan speed		
C 3	Geb1_PWM_AusAkt	Current fan control (PWM)		
C 4	RelModLevel	Relative output		
C 5	Pumpe_PWM	Pump setpoint (PWM)		<b>Not used</b>
C 6	ek0	Control differential		
C 7/ C8/ C9	Reserved			
<b>Setpoints (Service level) <sup>3)</sup></b>				
d 0	Reserved			
d 1	Tsoll	Setpoint of 2-position or modulating controller (PID)		
d 2	TkSoll	Current boiler temperature setpoint		
d 3	TsRaum	Room temperature setpoint		
d 4	TbwSoll	DHW temperature setpoint		<b>Not used</b>
d 5	PhzMax	Maximum degree of modulation in heating mode		
d 6	NhzMax	Maximum speed at maximum output in heating mode		
d 7/ d8/ d9	Reserved			

- Note <sup>1)</sup>
- 1 Press Info button 
  - 2 Press buttons for at least 3 seconds 
  - 3 Choose the relevant parameter with buttons 
- Note <sup>2)</sup>
- 1 Press Info button 
  - 2 Press buttons for at least 3 seconds 
  - 3 Press button 
  - 4 Choose the relevant parameter with buttons 
- Note <sup>3)</sup>
- 1 Press Info button 
  - 2 Press buttons for at least 3 seconds 
  - 3 Press button twice 
  - 4 Choose the relevant parameter with buttons 

Note after about 8 minutes, the display will automatically change to the default display.



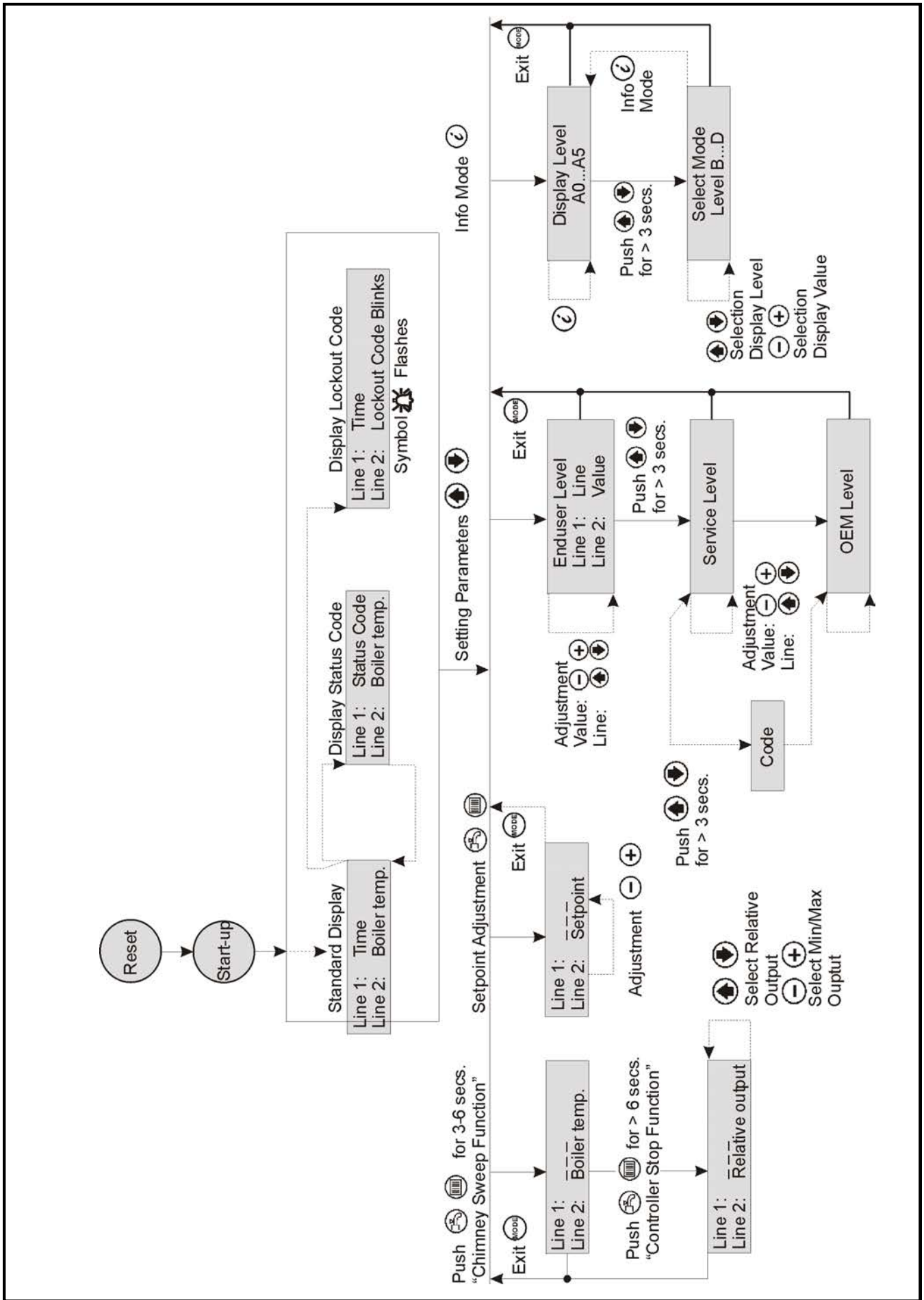

Figure 8.2.1.3 - Operation and display philosophy

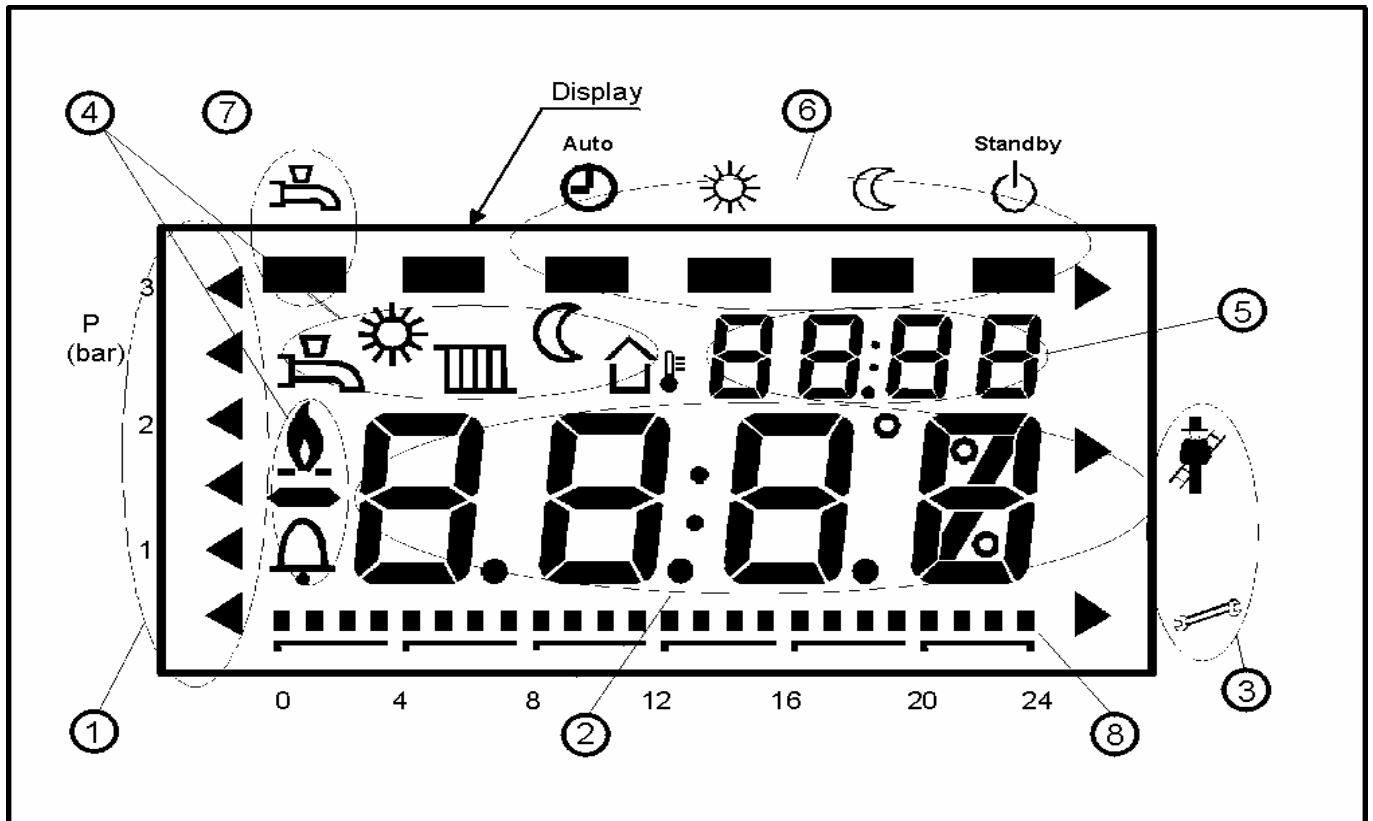













Figure 8.2.2 - Screen Legend

Character	Display	Function
①	Water pressure sensor signal	Display of water pressure (6 pointers)
②	Display (2) 4 x 7 large segments	Display of current value
③	Maintenance indicator flashing	Upper arrow - Chimney Sweep active Lower arrow - Controller Stop active
④	Display symbols	Meaning of symbols:  Display of dhw temperature or dhw heating active – <b>not used</b>  Display of boiler or room temp. set-point, or space heating active.  Display of outside temperature.  Operational level 'Normal'  Operational level 'Reduced'  Display of flame  Display of fault
⑤	Display (1) 4 x 7 small segments	Display of time of day, parameter settings or error code.
⑥	Operating mode of heating circuit	Operating mode is, or changes to:  Automatic  Continuous 'Normal' operation  Continuous 'Reduced' operation  Standby
⑦	Operating mode of dhw.	On or Off - <b>not used</b>
⑧	Time bar	Display of time program of heating circuit

### 8.2.3 - Default Display

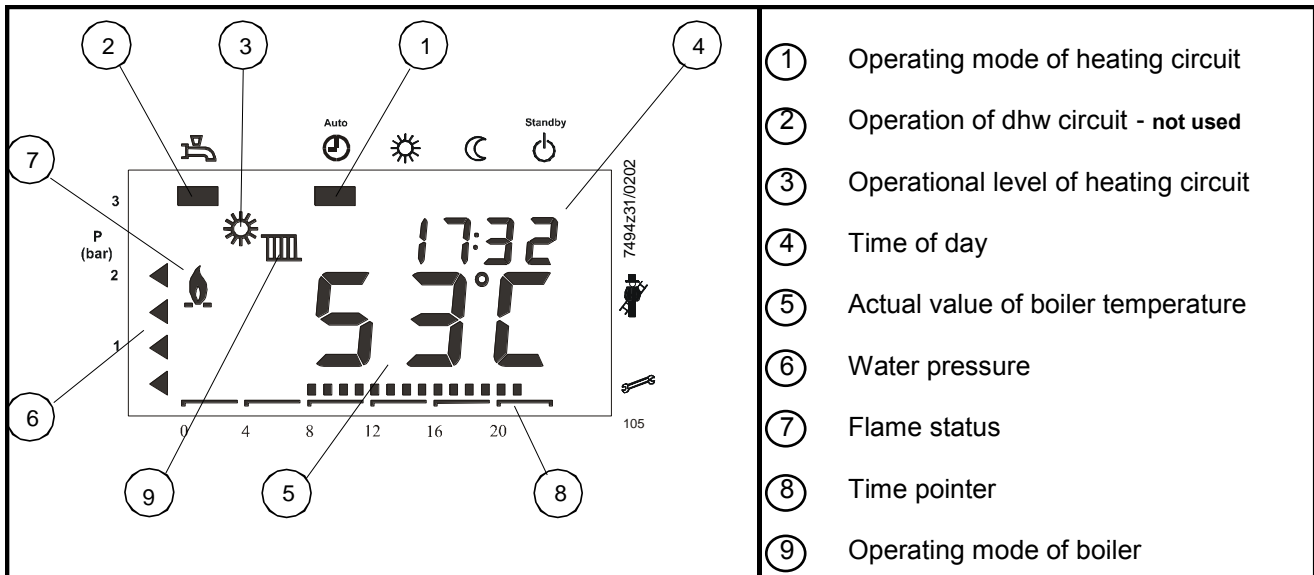

Figure 8.2.3.1 - Default display

If no button is pressed for about 8 minutes, the screen will automatically return to the default display.

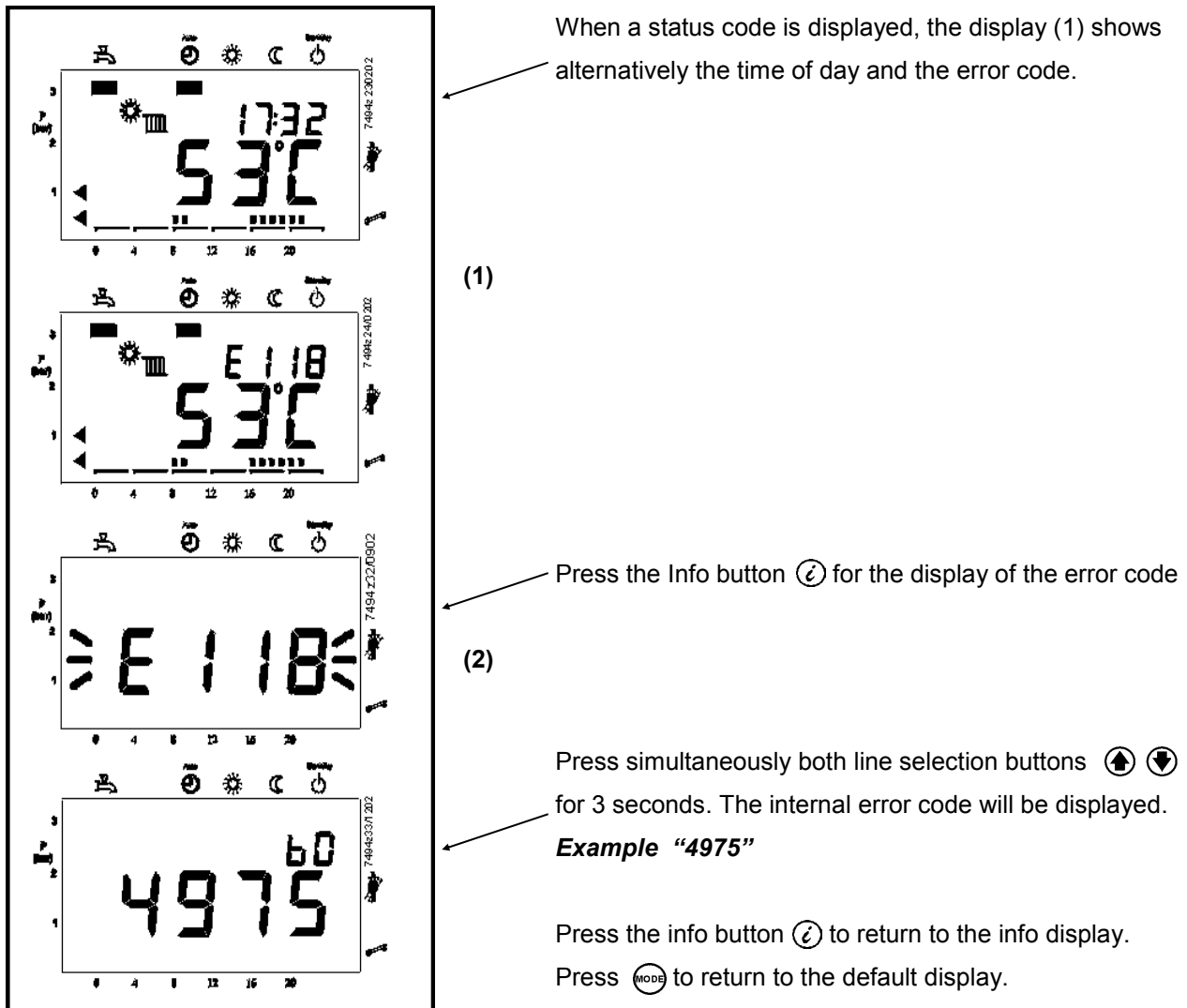

Figure 8.2.3.2 - Display of Status Code

## 8.2.4 - Lockout Display

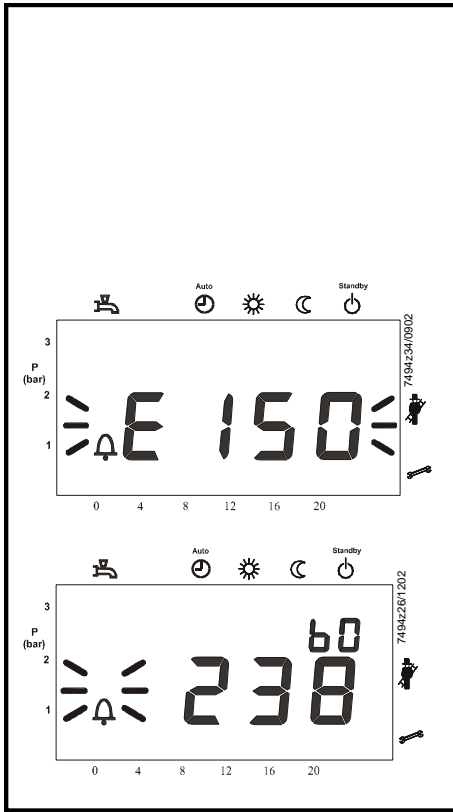

Figure 8.2.4 - Display of lockout code

In the case of a lockout code, the error code display flashes together with an 'Alarm symbol';

(1) The LMU will go to lockout

**Example: "E150"**

(2) Press the Info button (i) to switch to the error code

Press both line selection buttons (up/down) simultaneously for 3 seconds. The internal error code will be displayed

**Example "238"**

Press the Info button (i) to switch to the Info display

Press (MODE) to return to the default display

**Note:** After rectification of the fault, press the reset button (RESET) (>0.6 seconds) to reset the LMU.

## 8.2.5 - Adjusting the heating circuit setpoint temperature

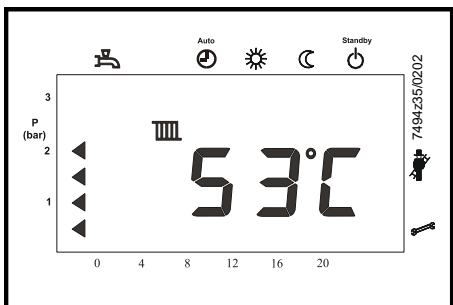

Figure 8.2.5 - Heating circuit setpoint temperature

Press the flow temperature button (radiator icon) to adjust the heating circuit setpoint

Press (-) (+) to adjust the required setpoint

(1)

Press (MODE) to return to the default value









Changes will be stored.

The room temperature setpoint or boiler temperature setpoint will be changed depending on the plant's configuration (with or without outside sensor).

If no button is pressed for about 8 minutes, the screen will automatically return to the default display. Changes will be stored.

## 8.2.6 - Parameter settings for the Enduser

The boiler is supplied with default settings. These must be modified to suit individual Enduser needs.

 	Press one of the line selection buttons. This will take you to programming level <<Enduser>>
 	Press the line selection button to choose the relevant line. The display shows <<Pxxx>>
 	Adjust the required value with one of these buttons. The adjustment is stored as soon as you change to some other line (to alter individual items, a change of parameter is required). The Enduser Parameter list details all possible settings.
	Press button to leave the programming level. Changes will not be stored
	Press the Info button to leave the programming level. Changes will be stored

**Note:** If no button is pressed for about 8 minutes, the screen will automatically return to the default display. Changes will not be stored. When switching to another level, changes will be stored.

Line	Function	Range	Unit	Resolution	Default value
<i>Time of day</i>					
1	Time of day	0...23:59	h / min	1 min	---
<i>Setpoints</i>					
5	Reduced room temperature setpoint «TrSollRed» or (reduced boiler temperature setpoint «TvSollRed») (When using an additional room unit, line 5 will be hidden)	TRF...TRN	°C	0.5	16.0
<i>Time program HK1 (heating circuit 1)</i>					
11	Time program HC1 switch-on time 1 <sup>st</sup> period	00:00...24:00	hh:mm	10 min	06:00
12	Time program HC1 switch-off time 1 <sup>st</sup> period	00:00...24:00	hh:mm	10 min	22:00
13	Time program HC1 switch-on time 2 <sup>nd</sup> period	00:00...24:00	hh:mm	10 min	24:00
14	Time program HC1 switch-off time 2 <sup>nd</sup> period	00:00...24:00	hh:mm	10 min	24:00
15	Time program HC1 switch-on time 3 <sup>rd</sup> period	00:00...24:00	hh:mm	10 min	24:00
16	Time program HC1 switch-off time 3 <sup>rd</sup> period	00:00...24:00	hh:mm	10 min	24:00

**Figure 8.2.6 - Overview of Enduser parameters**

## 8.2.7 - Start-up / initialisation

On startup after power-On, or after a lockout reset, the setpoints will be initialized.

These setpoints apply until a first adjustment is made (e.g. via the screen display or PC parameterization):



After a readjustment, these values will be overwritten with the new value and permanently stored in the LMU.

When a new startup is made, or after power-On, the previous settings will be stored in the LMU.

Also, the software version number of the operator module and that of the connected type of LMU... will be delivered.

## 8.2.8 - FUNCTIONS

### 8.2.8.1 - Chimney Sweep function

The chimney sweep function enables the boiler to be started up in heating mode by pressing both buttons   simultaneously for more than 3 seconds but for no more than 6 seconds.



**On the display, the upper arrow of the maintenance function flashes** and the currently selected temperature appears. This function serves for making measurements on the boiler. When the chimney sweep function is activated, the boiler will deliver maximum output until the limit thermostat cuts out.

To ensure maximum supply of heat, the chimney sweep function generates the forced signal for heat supply.



During the time that the Chimney Sweep is activated, an appropriate status code is delivered.

To close the function, press button 

### 8.2.8.2 - Controller Stop function

The controller stop function enables the boiler's heat output to be adjusted manually in heating mode by pressing both buttons   simultaneously for more than 6 seconds.

**On the display, both arrows of the maintenance function flash** and the currently selected temperature appears and the display shows the adjusted relative boiler output.

The function serves for making measurements on the boiler and allows the boiler output to be increased / decreased by pressing buttons  .



Minimum and maximum output can be directly selected by pressing the line selection buttons  .

**Note:** - If the controller stop function is triggered via PC tool ACS420, the current setpoint of burner output will appear on the display, but the settings are locked.

To close the function, press button .

### 8.2.8.3 - Time of day function

To ensure that this function operates, the time of day and time settings must be correctly set. Refer to section, Parameter settings for Enduser, to setup the program.

**Note:-** each time button   is pressed during the time setting, the seconds are set to 0 and the clock continues to run while making the setting.

### 8.2.9 - Heating circuit operating modes

The control provides 4 different heating circuit operating modes for LMU... heating circuit 1. They can be directly selected depending on the requirements - see figure 8.2.9

The operating modes are selected by pressing button .

On the LCD, a pointer below the respective symbol points to the selected heating circuit operating mode.

### 8.2.10 - Error code display

In the event of a nonvolatile LMU... lockout position, fault is continually displayed. In addition, the diagnostic code on the display flashes (refer to figure 8.2.4 and table 8.2.10).

To cancel the lockout position, press lockout reset button  for at least 2 seconds.

### 8.2.11 - Display of operating phases (display level A4)

The operating phases according to the LMU...’s sequence diagram can be displayed (display level A4 press Info button 3 times).

Assignment of the display code and the LMU...’s phase designation is as follows:





Operating mode	Designation	Effect of selection
	Automatic operation	Heating circuit 1 (HC1) according to time switch program 1
	Standby	Heating circuit 1 switched off Frost protection functions active
	Continuous 'Normal' operation	Heating circuit 1 continuously on according to the adjusted nominal room temperature setpoint or heating circuit setpoint
	Continuous 'Reduced' operation	Reduced room temperature set point or heating circuit frost protection setpoint

Figure 8.2.9

## 8.3 - Functions

### 8.3.1 Frost Protection

**Note:** - to access this function, the circulating pump must be wired to the LMU through a suitable contactor.

There are two levels of frost protection available dependent on the sensor options used.

1st stage - When the boiler water temperature is below 5°C, the burner and the heating pump are switched on. When the temperature increases and exceeds 15°C, the burner stops and the pump continues for the duration of the pump overrun.

2nd stage - This additional function uses the outside air temperature (if a sensor has not been fitted, the function is blocked) and provides three levels of activation.

- If the outside temperature is less than or equal to -5°C, the pump operates continuously
- If the outside temperature is between -4 & 1.5°C, the pump operates for 10 minutes every 6 hours.
- If the outside temperature is greater than 1.5°C, the pump is switched off.

Note:- any demand for dhw is given priority.

Should protection be required for the building fabric, then a QAA73 programmable room sensor must be used to maintain the internal building temperature.

### 8.3.2 Anti Legionella

To prevent the development of pathogenic bacteria in the domestic hot water tank during prolonged shut downs or low storage temperatures, the dhw must be heated once a week to a temperature greater than 60°C.

The anti legionella function heats the dhw once a week on Monday, after the first load, to 65°C.

### 8.3.3 Pump overrun

When the heating mode ends, the heating circuit pump remains on for a period (depending on the settings used - QAA73: 544).

In dhw systems, when the dhw heating period ends, the heating pump remains on until the return temperature drops below 70°C. During this period, the dhw selector valve (if fitted) is in the open position.

### 8.3.4 Pump or selector valve kick

If either the heating circuit pump or dhw selector valve have not been activated for more than 24hours, then during an off period the pump or valve is activated for 5 seconds.

### 8.3.5 Boiler overheat protection

The boiler flow sensor in combination with the return sensor, provide overheat protection as follows:

- If the first level temperature is exceeded, a fault code is displayed.
- If the second level temperature is exceeded, an alarm code is displayed and the boiler will switch off. The boiler must be reset to restart.

To restart the boiler, the temperature must fall, accordingly the fan and pump will continue to operate until the boiler heat exchanger temperature drops.

Additionally, should the  $\Delta T$  across the boiler heat exchanger exceed 25°C, the burner will reduce output to minimum rate. Should the  $\Delta T$  exceed 30°C, the burner will shutdown.

### 8.3.6 Anti-cycling

Dependent on the installation and the minimum firing rate of the boiler, the control monitors the heating temperature curve and will hold off a boiler from firing and thus reduce the number of operations.

### 8.3.7 Automatic summer / winter switching

Note: - This function is only available when an outside sensor is fitted.

The automatic summer/ winter switching function enables the summer mode to be switched to winter mode (vice versa) throughout the year, without the need for manual intervention.

The heating is shut down when the average outside temperature measured over the preceding 24hours is greater than 1°C above the set point (20°C).

The heating is automatically started up again when the average outside temperature measured over the preceding 24hours is less than 1°C below the lower limit of the hysteresis threshold of the set point (18°C).

Note: - The switch over setting is set to 19°C and can only be changed using the QAA73 room sensor.

The automatic mode must obviously be activated on the boiler as well as on the QAA73, for the function to operate. The function is automatically activated by a default setting in the QAA73.

### 8.3.8 - Start-up / initialisation

On startup after power-On, or after a lockout reset, the setpoints will be initialized.

These setpoints apply until a first adjustment is made (e.g. via the display or PC parameterization):

After a readjustment, these values will be overwritten with the new value and permanently stored in the LMU.

When a new startup is made, or after power-On, the previous settings will be stored in the LMU.

Also, the software version number of the operator module and that of the connected type of LMU... will be delivered to the display.

**Figure 8.2.10 LMU Error Codes**

<b>Error code</b>	<b>Internal Error-Code</b>	<b>Potential cause</b>	<b>Actions</b>
0		No entry in code	
10		Fault outside sensor	
20	142	Short Circuit Boiler Flow Sensor	Check temp sensor in water flow pipe & replace if necessary
	143	Open Circuit Boiler Flow Sensor	Check connections to temp sensor in water flow pipe Check temp sensor in water flow connection & replace if necessary
28		Fault flue gas sensor	
32		Fault flow temperature sensor 2	
40	144	Short Circuit Boiler Rtn Sensor	Check temp sensor in water rtn pipe & replace if necessary
		Open Circuit Boiler Rtn Sensor	Check connections to temp sensor in water rtn pipe Check temp sensor in water rtn connection & replace if necessary
50		Fault DHW temperature sensor 1	
52		Fault DHW temperature sensor 2	
61		Fault room unit 1	Check room device
62		Wrong room unit 1 or wrong radio clock connected	Connect compatible room control unit
77		Fault air pressure sensor	
78		Fault water pressure sensor	
81	518	LPB Short Circuit or no power supply	Check connections to clip in (switch off and isolate boiler before working on mains wiring)
82		Address collision on LPB...	Check addresses of connected modules
91		Data overflow in EEPROM	
92		Hardware fault in electronics	
95		Invalid time of day	Set correct time
100		2 clock time masters	
105		Maintenance message	P629 to reset : change from 0 to 1
110/111		Limit thermostat has cut out	Allow the boiler to cool and reset thermostat Investigate cause of overheating (see section 9.3)
113		Flue gas supervision equipment has cut out	
117		Water pressure too high	
118		Water pressure too low	
119		Water pressure switch has cut out	Check water pressure
128		Loss of flame during operation	Check connections to flame probe Investigate flame probe condition Check combustion when boiler is firing
130		Flue gas limit temperature exceeded	
132		Safety shutdown	Check gas pressure Check flue & condensate trap for blockages Check safety switches
133		No flame on completion of safety time	Check operation of gas valve. Check HSI
134		Loss of flame during operation	
140		Inadmissible LPB segment number/device N°	
148		Incompatibility LPB... interface / basic unit	
151	552	Relay clip in faulty	Check connections to clip in Check and replace clip in module (switch off and isolate boiler before working on mains wiring)
152		Fault in connection with LMU settings	
153		LMU has locked out	Press reset button (code appears if reset button is pressed when there are no faults)
154		Flow Problems	Check water flow through the boiler & Check the pumps
160		Fan speed threshold not reached	Check obstructions in fan, burner & flue. Check non-return valve operates Check heat exchanger for debris
161		Maximum fan speed exceeded	Check parameters
162		Fault air pressure switch (does not close)	
164		Fault heating circuit flow switch / pressure switch	
166		Fault air pressure switch (does not open)	
180		Chimney sweep function active	
181		Controller stop function active	
183		LMU... in parameter setting mode	



### 8.3.9 - BMS 0~10v DC control of LMU

The following parameters need to be changed on the boiler LMU when a BMS 0-10 V signal is being used to control the boiler modules directly.

All parameters can be changed using the keypad on the boiler display panel or via the computer link using the Siemens software.

Boiler	PC	Requ <sup>d</sup> setting	Function
618	526	4	0–10 V - temperature
618	526	5	0–10 V - load
622	528	As req'd (80°C)	Max temp = 10 V
623	529	As req'd (20%)	Min % load = 20 %

It may be necessary, depending on the operating temperature required, to raise the maximum operating temperature possible from the individual boiler modules. As standard the boiler modules leave

the factory with a maximum operating temperature of 80°C. Where a higher operating temperature is required the following parameter change must be made.

505 181 As req'd (90°C) Max operating temp.

### 8.3.10 - Access to LMU Fault Log

The LMU control retains historical fault information of the last 6 faults, as read only via the Engineer level access.

The current fault relates to the actual lockout at the time of the visit. Once reset, the current fault becomes the 1st fault and the remaining history is shifted back to the 5th fault, losing the previous 5th fault history.

The Albatros code is the 'E' display code supported by the internal code

No QAA73... AGU2.310	Function	Level QAA73... AGU2.310
700	1st past value of lockout code counter	Engineer *
701	1st past value of lockout phase	Engineer *
702	1st past value of internal diagnostic code	Engineer *
728	1st past value of ALBATROS error code	Engineer *
703	2nd past value of lockout code counter	Engineer *
704	2nd past value of lockout phase	Engineer *
705	2nd past value of internal diagnostic code	Engineer *
729	2nd past value of ALBATROS error code	Engineer *
706	3rd past value of lockout code counter	Engineer *
707	3rd past value of lockout phase	Engineer *
708	3rd past value of internal diagnostic code	Engineer *
730	3rd past value of ALBATROS error code	Engineer *
709	4th past value of lockout code counter	Engineer *
710	4th past value of lockout phase	Engineer *
711	4th past value of internal diagnostic code	Engineer *
731	4th past value of ALBATROS error code	Engineer *
712	5th past value of lockout code counter	Engineer *
713	5th past value of lockout phase	Engineer *
714	5th past value of internal diagnostic code	Engineer *
732	5th past value of ALBATROS error code	Engineer *
715	Current value of lockout code counter	Engineer *
716	Current value of lockout phase	Engineer *
717	Current value internal diagnostic code	Engineer *
733	Current value of ALBATROS error code	Engineer *

Figure 8.3.10—LMU Fault Log

**Note :**

When connecting to a QAA73 unit refer to Hamworthy OEM manual 500001305

When connecting to a Merley RVS control unit refer to Hamworthy OEM manual 500001210

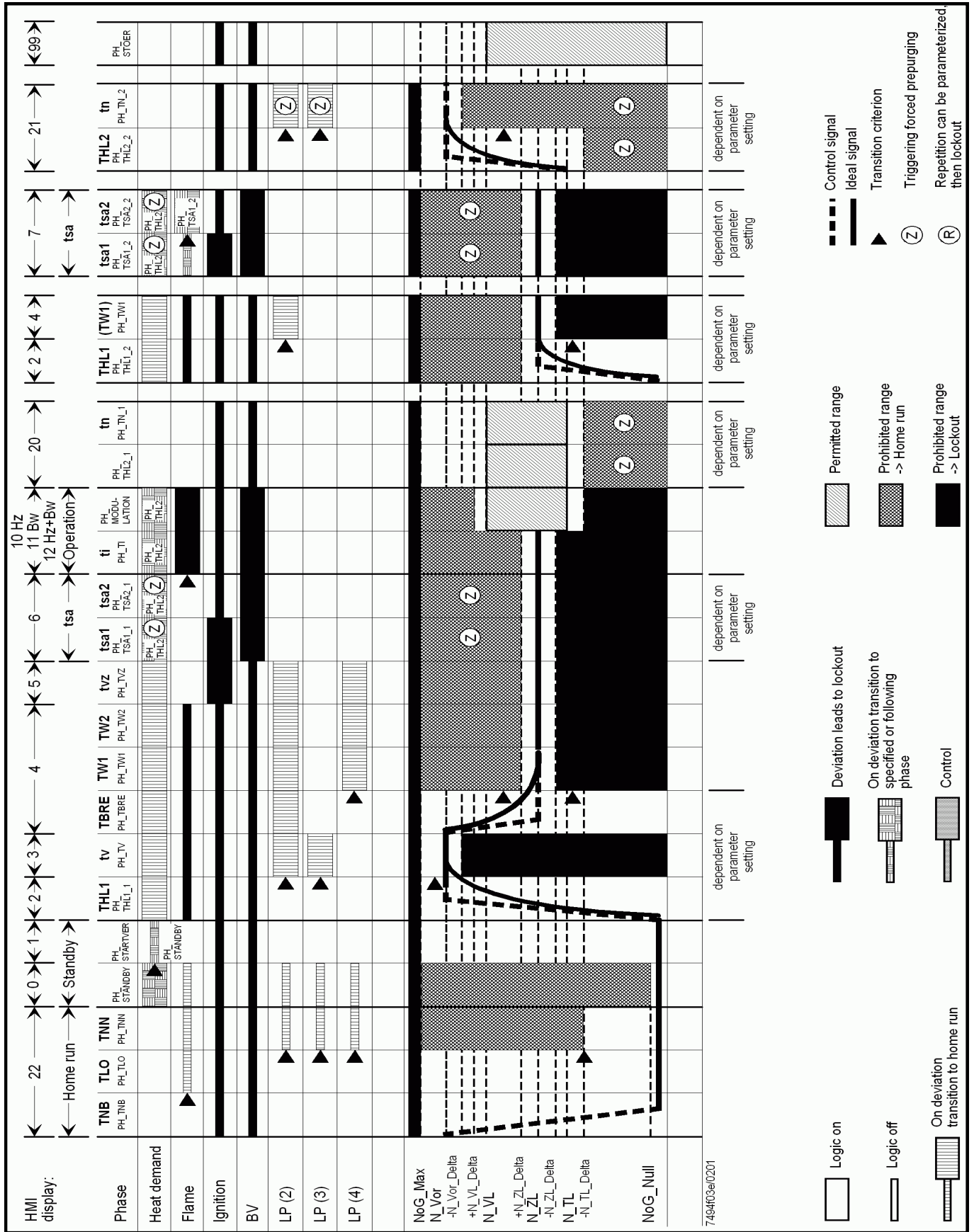

Figure 8.3.11 - Operating phases

Display	Meaning	Internal operating phases of the LMU...
00	Standby (no demand for heat)	PH_STANDBY
01	Prevention of startup	PH_STARTVER
02	Fan runup	PH_THL1_1 PH_THL1_2
03	Prepurging	PH_TV
04	Waiting time	PH_TBRE PH_TW1 PH_TW2
05	Preignition time	PH_TVZ
06	Safety time, constant	PH_TSA1_1 PH_TSA2_1
07	Safety time, variable	PH_TSA1_2 PH_TSA2_2
10	Heating operation	PH_TI PH_MODULATION Heating mode
11	DHW operation	PH_TI PH_MODULATION DHW mode
12	Parallel operation of space heating and DHW heating	PH_TI PH_MODULATION Heating and DHW mode
20	Postpurging with the last control of operation	PH_THL2_1 PH_TN_1
21	Postpurging with control of prepurging	PH_THL2_2 PH_TN_2
22	Home run	PH_TNB PH_TLO PH_TNN
99	Lockout position (display of the current error code)	PH_STOER

**Note:** -If operating phases are passed very quickly or skipped, the relevant display code will not appear.

**Figure 8.3.12 - Operating phases**

#### 8.4 Ignition Controller Check.

1. With the burner firing, the flame signal should be at least 3 $\mu$ A. Refer to **Figure 8.2.9 - Maintenance functions**. To check for correct operation of the ignition controller, close the gas valve. The boiler should shutdown after approximately one second and attempt a re-ignition. Check that the flame has been extinguished

2. Alternatively, the flame probe lead can be removed from the end of the flame probe, with the same result.

#### 8.5 Gas Supply Pressure Check.

1. When the boiler modules have been checked for correct operation the gas supply pressure should be checked. This should be done with all modules firing.

- For Natural Gas, a nominal gas inlet pressure of 20mbar measured at the rear of the boiler is required, with a maximum inlet pressure of 25mbar.
- For LPG, a nominal gas inlet pressure of 37mbar measured at the rear of the boiler is required, with a maximum inlet pressure of 45mbar.

#### 8.6 Combustion Checks

**“The boiler modules are factory pre-set, but, site checks must be done to confirm correct performance.”**



2. Use appropriate tool to remove sample point plug from front of combustion chamber.

**Figure 8.6.1 - Removal of Sample Point Plug**

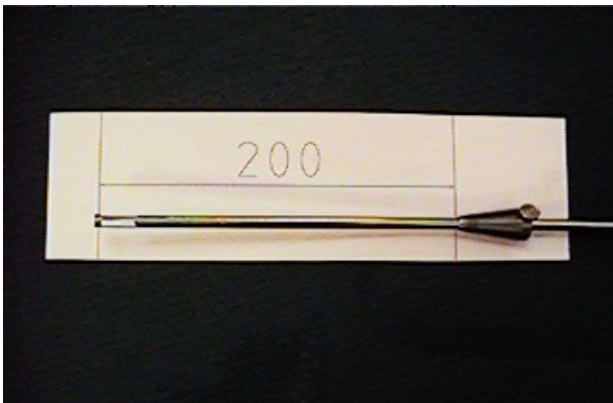

3. Ensure that an insertion distance of 200mm is set on the combustion analyser probe.

**NOTE: THIS DISTANCE MUST BE SET TO ENSURE ACCURATE ANALYSIS OF FLUE GASES.**

**Figure 8.6.2 - Combustion Analyser Probe Setting**



4. Insert probe horizontally into combustion chamber until depth stop is met.

**Figure 8.6.3 - Insertion of Analyser Probe**

If combustion is outside of the ranges defined below the factory sealed valves may be adjusted using the following procedure :

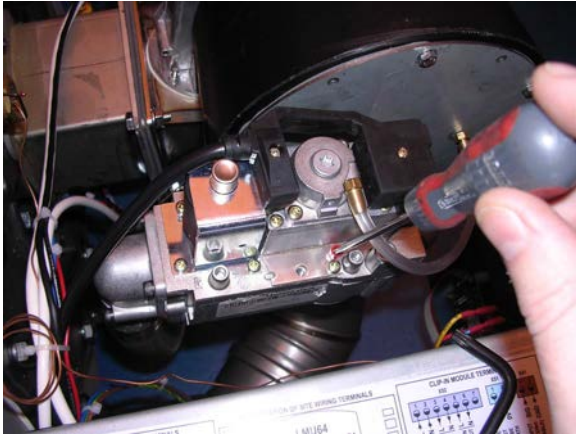

**100c & 120cc**

High Fire Target **Nat Gas - 9.0% ±0.25% CO<sub>2</sub>**  
**LPG - 10.6% ±0.25% CO<sub>2</sub>**

If combustion level is outside of this range use the Cross Head Throttle Screw to adjust the mixture.

**THIS SETTING MUST BE CORRECT BEFORE CONTINUING To increase the CO<sub>2</sub> level, turn the adjustment anti-clockwise.**

**Figure 8.6.4 - Adjusting gas valve throttle**

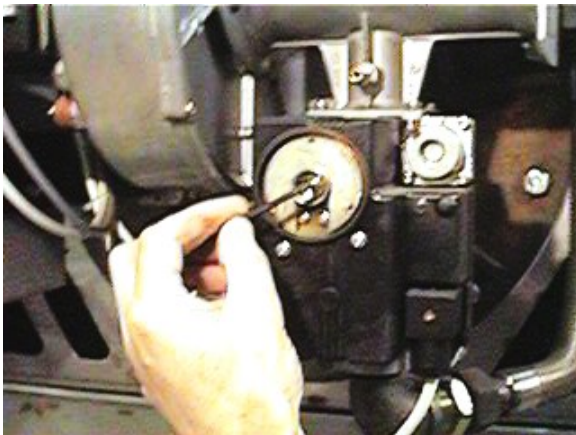

**150c/200c/250c**

High Fire Target **Nat Gas 9.0% ±0.25% CO<sub>2</sub>**  
**LPG - 10.6% ±0.25% CO<sub>2</sub>**

If combustion level is outside of this range use the Cross Head Throttle Screw to adjust the mixture.

**THIS SETTING MUST BE CORRECT BEFORE CONTINUING To increase the CO<sub>2</sub> level, turn the adjustment anti-clockwise.**

**Figure 8.6.4 - Adjusting gas valve throttle**

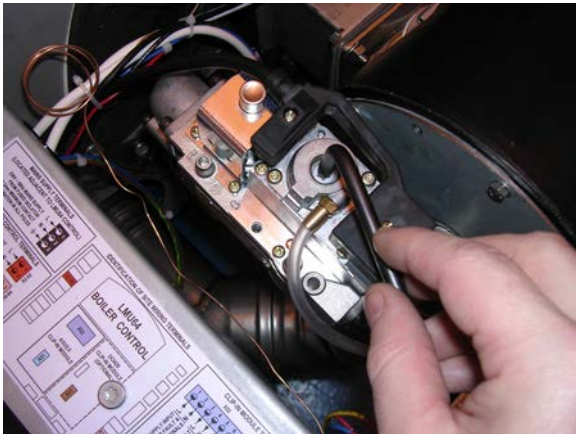

**100c & 120c**

Low Fire Target **Nat Gas 9.0% ±0.25% CO<sub>2</sub>**  
**LPG - 10.6% ±0.25% CO<sub>2</sub>**

If combustion readings are outside target range use Torx Bit to make adjustments

**To increase the CO<sub>2</sub> level, turn the adjustment clockwise.**

**Figure 8.6.5—Adjusting gas valve offset**

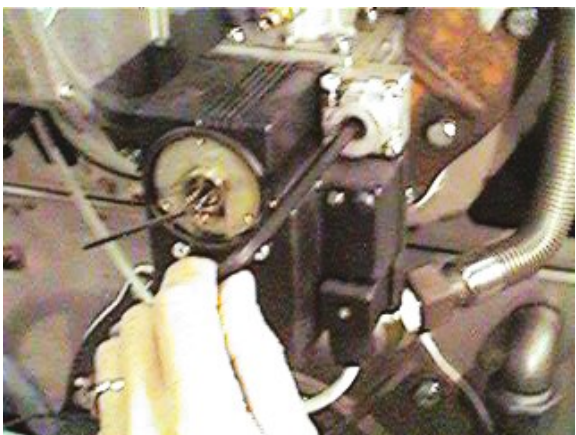

**150c/200c/250c**

Low Fire Target **Nat Gas 9.0% ±0.25% CO<sub>2</sub>**  
**LPG - 10.6% ±0.25% CO<sub>2</sub>**

If combustion readings are outside target range use Torx Bit to make adjustments

**To increase the CO<sub>2</sub> level, turn the adjustment clockwise.**

**Figure 8.6.5—Adjusting gas valve offset**

**(Note: Above readings taken with front cover removed and 200mm probe insertion CO = < 60 ppm\*).**

5. Energise electrical supply and start the boiler module. The burner will ignite and run at 100% modulation.
6. Monitor the combustion readings on the combustion analyser at both Maximum and Minimum firing rates.

**\*Figure must not exceed 200ppm under normal operating conditions.**

**If combustion readings fall within the required range the boiler module is set and operating correctly. If the combustion readings fall outside the required range the burner settings will require adjustment.**

#### **CONTACT HAMWORTHY HEATING TECHNICAL DEPARTMENT FOR FURTHER DETAILS**

7. Shut down the boiler and isolate from the electrical supply. Remove instrumentation and replace test points and plugs.
8. Refer to **section 8.1 - Controls Operation**, to adjust the relevant boiler settings specific to the installation

#### **8.7 User Instructions.**

When the boiler is fully commissioned, the owner or their representative should be made aware of the lighting-up and operating instructions. A practical demonstration should be given describing each functional step. This Installation and Commissioning guide, the servicing instructions manual and the user's instructions should then be handed over and be kept in a safe place for future reference.

#### **9.0 FAULT FINDING**

The Wessex ModuMax boiler is equipped with full self-diagnostic fault indication, with faults allocated a code, which is displayed (flashes) on the display - refer to **section 8.3.9 - Maintenance functions**.

The common fault codes are detailed in **section 8.3.9 - Maintenance functions**.. Fault codes not detailed in this manual should only be investigated by an Engineer.

**Should a fault code appear which cannot be reset, or a fault code repeatedly occurs, contact Hamworthy Heating for assistance. Do not continue to operate or use the boiler as this may cause damage to the controls.**

#### **9.1 Safety Temperature Limiter (Limit Thermostat)**

1. The electronic control thermostat has several safety levels built in such that a controlled shutdown should occur before the safety temperature limiter is activated. Should these safety levels be overridden (say external pump overrun failure after shutdown) the safety temperature limiter will trip initiating a boiler shutdown, preventing the boiler from firing. The code **(1 11)** on the controls display will flash indicating that the safety temperature limiter has tripped.
2. Before attempting to reset the safety temperature limiter (**See Figure 8.1.7**) the boiler must be allowed to cool to normal operating temperature. If, after pushing the reset pushbutton and resetting the lockout (refer to **section 8.1.1 - Controls Operation**), the lockout code on the display does not extinguish and the boiler does not fire up, it is possible that the safety temperature limiter will not reset because the boiler is still too hot.
3. Always carry out an investigation to ascertain the reason for overheating. The most common cause of overheating lack of water flow rate through the boiler - possibly due to external pump problem.

#### **9.2 Ignition Controller**

1. The flame is under constant supervision by the burner ignition controller. The controller monitors the flame's ability to rectify an AC current. If the flame diminishes for whatever reason and the rectified current drops below the controller's minimum detection current (3µA DC), the controller will de-energise the gas control valve within 1 second and commence a restart. Failure to establish and detect a flame during the light-up sequence will result in burner shutdown and lockout within 5 seconds, requiring a manual reset to restart the ignition sequence. Refer to **section 8.3.9—Maintenance functions**..
2. If the boiler continues to lockout, then an investigation must be made to ascertain the cause. **Refer to figure 8.3.10 - Operating faults**, for possible causes of lockout.
3. A false flame signal at the start and during pre-purge will cause the boiler module to restart its ignition sequence at the end of the pre-purge period. If this occurs 3 times in succession the controls will disable operation of the boiler module, requiring reset of the module. Refer to **section 8.3.10 - Operating faults**

Figure 9.3.2 - Wiring Diagram

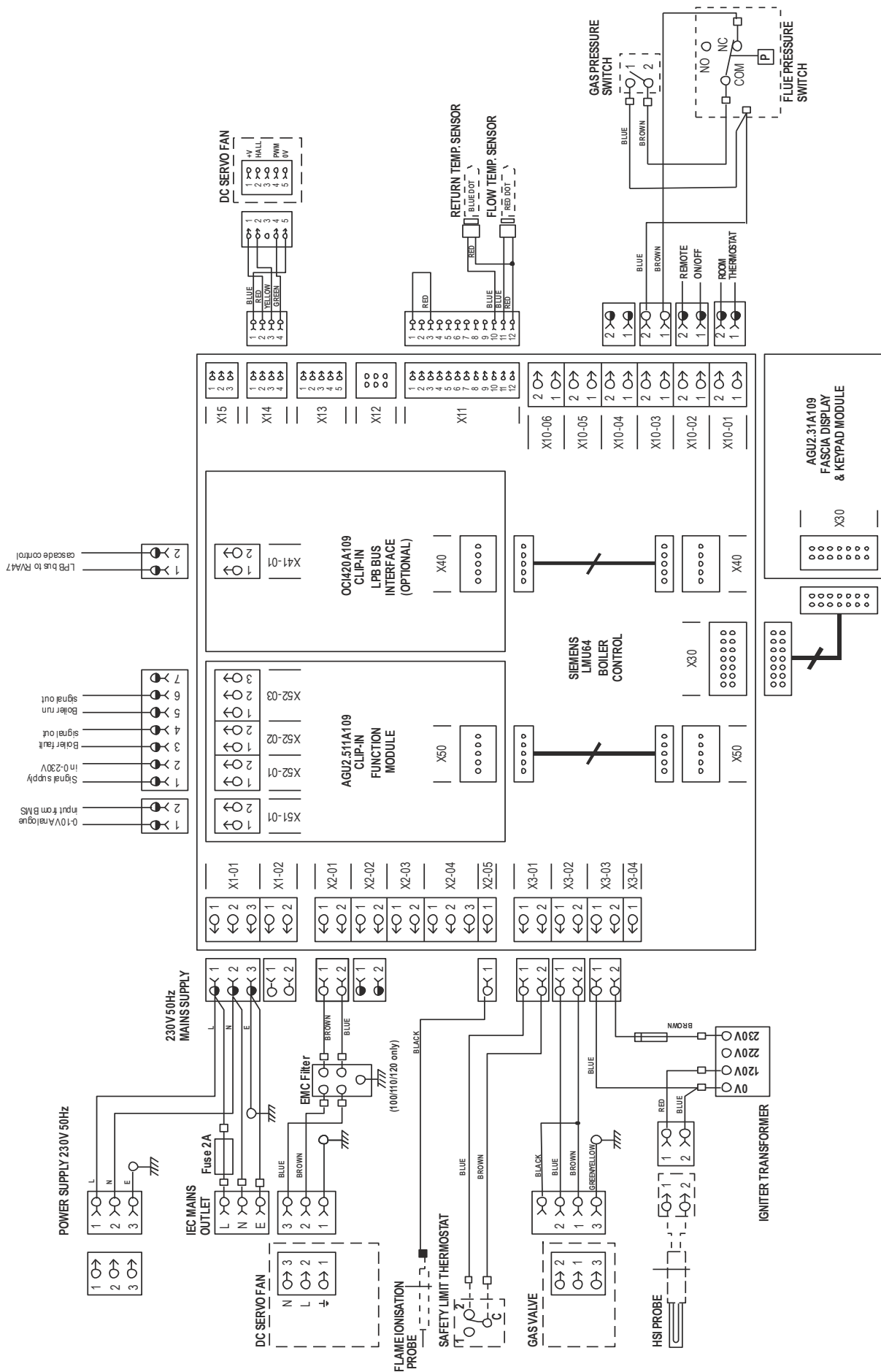

## **10 SERVICING**

A competent person registered for working on non domestic gas appliances should check and ensure that the flue, its support and terminal, the ventilation to the boiler house, safety valve, drain, water filter if fitted, pressure gauge, etc.; are in a serviceable and working condition and still comply with the relevant standards and codes of practice - see **Section 4**.

**10.1 Regular servicing is recommended**, preferably by a Hamworthy appointed person, and at least annually, to ensure trouble free operation.

For Wessex Modumax, Hamworthy would recommend an additional 6 monthly examination following commissioning, acknowledging site conditions and running hours.

Although cleaning of flueways may not be necessary on a yearly basis, it is important that all controls and safety features are checked for correct operation.

**Note:-** Measuring flue gas CO<sub>2</sub> and gas temperatures will give an indication of the state of the boiler flueways and waterways. Results should be compared with previously measured values to establish possible loss of efficiency.

Should remedial work be carried out on a module, then the non-firing module must be electrically isolated so as to prevent accidental operation in the event that the installation is required for ongoing heating requirements.

### **10.2 Annual Service**

The procedure detailed relates to a single module and **MUST** be carried out on ALL individual modules which constitute a unit. Before servicing the boiler, the following procedure must be carried out :-

**WARNING: Isolate all electrical supplies and turn off the gas service valve.**

**1)** Remove the front casing door by unscrewing the centre latch. Note the latch arm passes through a horizontal keyhole slot that requires the arm to be correctly aligned prior to removal of the cover.

**2)** Disconnect the H.S.I. and flame probe connectors from the respective probes.

**3)** Disconnect the fan power supply and control leads from the fan taking care with the latch on each connector.

**4)** Check that the gas service valve is closed, then undo the lower connection union on the flexible hose (at gas service valve connection).

**5)** Carefully disengage the air inlet duct from the air box (100c & 120c only) and remove the electrical plug from the gas valve.

**6)** Remove the 2 M8 burner retaining nuts and carefully withdraw the complete burner/ fan assembly from the

heat exchanger. Separate the burner fabrication from the fan, venturi and gas control valve .

**7)** Remove and inspect H.S.I. and flame probe, ensure they are free from debris or deposits. Test resistance value of H.S.I. if above 110 ohms (cold), replace with a lower resistance unit. Check respective positions – See Figure 10.2.

**Note:-** The H.S.I. element is very fragile.

**8)** Check the burner and clean using a soft brush if required (if possible use a vacuum cleaner to remove the dust from inside the burner tube). After cleaning the inside, the burner tube can be washed using a soapy water solution. Tap the burner flange firmly downwards on a block of wood to dislodge any residual debris from inside the burner tube. A damaged or cracked burner should be replaced.

**Note:-** Do not use a wire brush to clean the burner.

**9)** Separate the gas valve from the airbox by undoing the 6-M5 hex. head screws (100c & 120c only). Ensure venturi mouth and gas feed tube is clean and free of obstruction.

**10)** Inspect the fan scroll and impellor, clean and check for damage.

**11)** Inspect the non return valve in the burner inlet duct for smooth operation. If venturi is removed it must be put back in exactly the same position.

**12)** Separate the inlet flange and elbow fitting from the gas control valve by removing the 4 M5 socket cap head screws. Check that the mesh inlet filter in the gas valve is clear of debris, remove any foreign objects caught in the filter.

Re-assemble in reverse order taking care to inspect and if necessary, replace any o-rings, gaskets or seals.

Refer to **Section 8, Commissioning and Testing**, and test all gas joints broken or disturbed for soundness before firing.

Carry out a combustion check by testing the flue gas CO<sub>2</sub> and CO levels as detailed in **Section 8.2**.

### **10.3 Four Year Service**

Repeat the annual service as previously described but do not refit any components to the heat exchanger.

**10.3.1** To clean the heat exchanger, the use of a high pressure water hose (40-80 psi) is recommended. However provision must be made for the drainage of water used in this process. At the rear of the boiler module remove the condensate drain trap assembly from the casing by unfastening the 2 M6 nuts, to expose the opening in the casing. The cleaning water and any debris will exit the casing through this opening. On



**Figure 10.2 - Hot Surface Igniter and Flame Sensing Probe Positions**

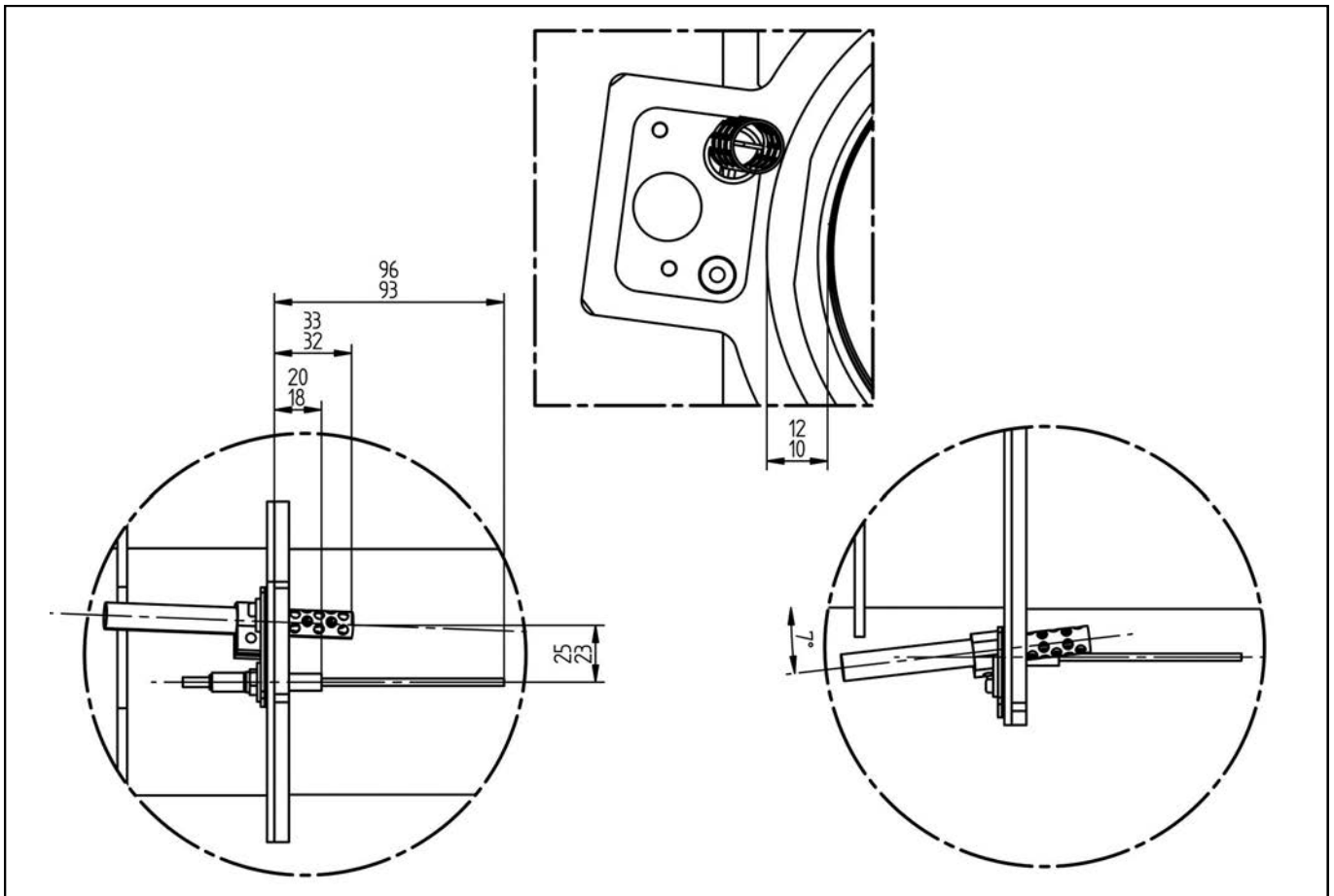

completion ensure that the opening is clear of debris and refit the condensate drain trap assembly, renewing the gasket if required.

**10.3.2** Should a high pressure hose not be available, the heat exchanger will have to be removed from the module casing. Isolate the heat exchanger from the flow and return water pipework and drain down. Remove all fittings from the water flow and return connections (including sensors and pockets) and remove the safety valve (if fitted) or 3/4" cap. Unfasten the 10 M8 nuts securing the water connection sealing plates and the safety valve pipe sealing plate, and remove all sealing plates and o-rings.

The boiler heat exchanger assembly is heavy, 100c & 120c weigh 100kg each & 150c/200c/250c weigh 130kg. It is recommended that a suitable lifting apparatus is used to support the weight of the heat exchanger, an M12 lifting eye nut can be fitted to the M12 stud at the top of the heat exchanger front plate for this purpose. Before connecting the lifting equipment to the lifting eye, hang a new heat exchanger to casing sealing gasket over the lifting eye, with the adhesive side facing the boiler. This will enable the new gasket to be fitted on re-assembly without cutting it!

Remove the 6 M10 nuts that retain the heat exchanger into the boiler module casing, and with the front end supported slowly withdraw the heat exchanger until the rear of the stainless steel baffles are visible. With the

rear of the heat exchanger resting in the body of the boiler and the front supported by the lifting apparatus, access is gained for removal of the stainless steel baffles. The silicon sealant between the baffle and the end plates must be peeled away, before attempting to remove the baffles. Unhook the stainless steel springs and remove the baffle plates to expose the finned tube bank. Wire brush both sides of the baffles to remove any deposits. Thoroughly wire brush the finned tubes and ensure that all debris is removed from the centre of the heat exchanger.

Remove the heat exchanger from the boiler body.

Remove the bolts and nuts securing the heat exchanger front cover plate. Remove the bolts securing the heat exchanger rear cover plate. Clean and de-scale all surfaces of the heat exchanger tube header castings and cover plates, and internal surfaces of the finned tubes and water connection nipples. Chemical de-scaling is preferred for the tube bank assembly.

**Note:** Always follow the chemical manufacturer's instructions to ensure correct application and safety.

Re-assemble the baffle plates by fitting one of the stainless steel springs and inserting the baffles beneath it, then fitting the second spring. When all the baffles are in place the gap between the ends of the baffle and the end plates must be sealed with silicon sealant. Remove the existing heat exchanger to casing sealing gasket

and fit the new gasket previously hung on the lifting eye. Clean mating surfaces of the heat exchanger tube header castings and cover plates. Re-assemble the heat exchanger assembly using new gaskets (a light coating of grease applied to gasket faces will assist seal).

Refit heat exchanger ensuring correct rotational orientation, so that the water connection nipples and safety valve pipe pass through the holes in the rear of the casing, fastening in place with the 6 M10 nuts. Refit the water connection and safety valve pipe sealing plates, renewing all gaskets and o-rings. Reconnect the system pipework and check for soundness.

Ensure that the cover plates are re-fitted in the correct orientation. Evenly torque the bolts and nuts to 7kg m.

Re-fit the burner assembly. **Test all gas joints broken or disturbed for soundness before firing.**

Refer to **Section 8 Commissioning The Boiler**, for correct procedures.

### **11.0 REPLACEMENT OF FAILED COMPONENTS**

There are a number of components listed below which can be replaced simply and quickly by following the given procedure. In each case the operation of each replaced component must be checked by carrying out the appropriate part of the commissioning procedure. See **Section 8: COMMISSIONING & TESTING**.

**Note:- Isolate all electrical supplies to the boiler module before removing the front cover and commencing any servicing or component exchange procedure. With the front cover removed, turn off the gas supply at the service valve.**

#### **11.1 Hot Surface Igniter and Flame Probe Assembly Part Nos. 563801019 & 533805019**

**Note:- The igniter and flame probe ceramics are very fragile.**

Unplug the igniter from the harness, remove the single socket cap head screw securing the igniter to the burner flange and withdraw the igniter. When fitting the replacement carefully feed the igniter through the mounting hole and secure with the socket cap head screw.

Disconnect the flame probe lead, remove the single socket cap head screw securing the probe to the burner flange and withdraw the probe. When fitting the replacement carefully feed the probe through the mounting hole taking care not to damage the ceramic.

**Note:-** Do not remove both securing screws at the same time as the separate flange and Mica sight glass will become detached.

Ensure the positions of the igniter and probe are as recommended in Figure 10.2.

#### **11.2 Flow / Return sensor**

##### **Part No. 533901431**

The two identical sensors are located in pockets on the flow and return pipes at the rear of the boiler. To remove the sensor, unplug the sensor from the harness, loosen the M3 screw securing the sensor in the pocket and withdraw the sensor.

Upon replacement ensure that the sensor is fully engaged and secured into the pocket.

#### **11.3 Temperature Limiter (Limit Stat)**

##### **Part No. 533901179**

It is possible that the replacement temperature limiter will not be identical to that originally fitted as an alternative model may have been used. They are interchangeable but their physical layout and electrical terminals are positioned differently. It is therefore important to identify the two limiters by reference to Figure 11.3 before attempting the replacement.

To replace the limiter, remove the plastic cover, undo the shaft securing nut and withdraw the limiter rearwards from the controls fascia. Remove the electrical connections from the limiter body noting the position of the coloured cables.

Check the operation of the replacement device after ensuring the reset button has been fully depressed, by carefully applying a heat source to the bulb. Check the setting of the original limiter and adjust the replacement to the same temperature but it must not exceed a maximum of 100°C.

Fit the replacement limiter in reverse order ensuring that the electrical connections are in the correct positions as when removed and as identified with reference to Figure 11.3 – Identification of Temperature Limiters and Wiring Connections and Figure 9.3.2 – Wiring Diagram. Before replacing the plastic cover, ensure the limiter has been reset by fully depressing the central button.

**figure. 11.3 :**

Identification of temperature limiters & their connections

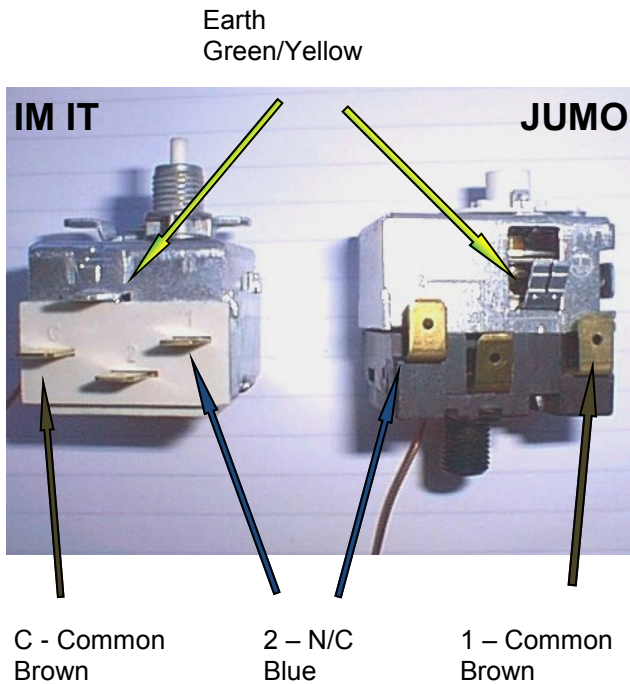

#### 11.4 Gas Valve

**Part No. 533903037 (100c & 120c)**

**Part No. 563903005 (150c/200c/250c)**

**Note:-** Some gas valve components can be replaced without completely removing the whole assembly from the boiler. However, Hamworthy Heating strongly recommend that a complete new gas valve is fitted to ensure safe, reliable operation of the boiler. Please refer to Hamworthy Heating Technical Department before attempting to remove components from the gas valve.

**Note:-** An LPG orifice is fitted to each boiler module, (150c/200c/250c only) located between the gas valve outlet and venturi.

Ensure that the boiler module electrical power and gas supplies are isolated. Unfasten the gas valve plug securing screws and disconnect the plug by pulling firmly away from the valve. Unfasten the low gas pressure switch plug and remove the low gas pressure switch from the gas valve (100c/120c only) by removing the securing screw.

Remove the 4 M5 cap head screws securing the gas valve to the gas inlet flange, allow the flange to hang free on the flexible gas pipe. Remove the 4 M5 cap head screws securing the gas valve to the gas feed pipe, taking care to support the weight of the valve. Note that the cap head screws are different lengths at the inlet and outlet of the valve, be sure to replace at the correct positions.

Replace the gas valve complete with new 'O' rings, ensuring correct orientation - gas flow is in the same direction as the arrow marked on the valve. Replace the LPG orifice, if fitted. Replace the gas valve leads, ensuring correct plug positions and orientation, and secure firmly with the retained screws.

Refit the low gas pressure switch (100c/120c only) and secure the electrical plug with the retaining screw.

Check the setting of the gas supply pressure switch, and adjust if necessary. Unfasten the single pozi pan head screw to remove the cover if adjustment is required. Replace the cover after setting the switch to 12.5mbar

Switch on the boiler module gas supply and check for integrity of all joints using a proprietary leak detector. Refer to Figure 7.1 if necessary for valve integrity check procedure. Switch on the boiler module electrical power supply and ensure gas valve operation is correct and safe before continuing.

Re-light the boiler module. For correct settings and procedures refer to **Section 8.0 Commissioning The Boiler.**

#### 11.5 Combustion Fan

**Part No. 533704007 - (100c & 120c)**

**Part No. 533704003 - (150c/200c/250c)**

Ensure that the boiler module electrical power supply is isolated before removing the front cover and gaining access to the controls.

##### 100c & 120c

Disconnect the fan power supply and control leads from the fan. Remove the 6 M5 screws securing the gas valve and gas feed pipe to the air inlet box. Support the weight of the assembly and put to one side on the flexible gas supply hose.

Remove the 3 M4 hex head screws, nuts and washers fastening the venturi to the air inlet box. Remove the 4 M5 screws securing the air inlet box to the fan body. Disengage the air inlet box from the air inlet duct and remove from the fan. Remove the 4 M5 screws securing the fan outlet to the burner flange and remove the fan.

##### 150c/200c/250c

Disconnect the fan power supply and control leads from the fan. Separate the venturi and gas control valve from the fan by unfastening the 6 M8 socket dome head screws. Make provision to support the weight of the venturi and gas control valve whilst not connected to the fan.

Remove the 4 M8 hex head screws, nuts and washers fastening the fan to the burner and remove the fan.

Fit the replacement in reverse order, and if required replace any seals or gaskets.

**Note:-** After re-making any gas or combustion circuit joint/connection, an integrity check is recommended to ensure safety.

## 11.6 Venturi

**Part No. 532418002 - (100c & 120c)**

**Part No. 532418001 - (150c/200c/250c)**

Ensure that the boiler module electrical power supply is isolated before removing the front cover and gaining access to the controls. Isolate the boiler module gas supply by closing the gas service valve.

### 100c & 120c

Remove the 6 M5 screws securing the gas valve and gas feed pipe to the air inlet box. Support the weight of the assembly and put to one side on the flexible gas supply hose.

Remove the 3 M4 hex head screws, nuts and washers fastening the venturi to the air inlet box, ensuring correct orientation.

### 150c/200c/250c

Remove the 4 M5 socket cap head screws from the venture gas inlet flange and separate the gas control valve from the venture. Make provision to support the weight of the valve assembly whilst not connected to the venture. Separate the venture from the fan by unfastening the 6 M8 socket dome head screws.

Fit the replacement in reverse order, and if required replace any seals or gaskets.

**Note:- (100c & 120c)** the venturi is supplied with an air inlet ring, the position of which is factory set. Do not adjust the position of the ring.

## 11.7 Burner

**Part No. 533301019 - (100c & 120c)**

**Part No. 533301020 - 150c**

**Part No. 533301021 - 200c**

**Part No. 533301024 - 250c**

Disconnect the H.S.I. and flame probe connectors from the respective probes. Disconnect the fan power supply and control leads from the fan taking care with the latch on each connector.

Unscrew retaining screws and remove the electrical plugs from the gas valve and low gas pressure switch.

### 100c & 120c

Check that the gas service valve is closed, then undo the lower connection union on the flexible hose (at gas control valve inlet elbow). Remove the 6 M5 screws securing the gas valve and gas feed pipe to the air inlet box. Support the weight of the assembly and put to one side on the flexible gas supply hose. Separate the burner fabrication from the fan and air inlet box assembly.

### 150c/200c/220/250c

Undo the lower connection union on the flexible hose (at gas control valve inlet elbow). Remove the 2 M8 burner retaining nuts and carefully withdraw the complete burner assembly from the heat exchanger. Separate the burner fabrication from the fan, venturi and gas control valve.

**Note** the assembly of the non return valve in the burner inlet duct. Inspect the non return valve for smooth operation.

Remove and inspect H.S.I. and flame probe, ensure they are free from debris or deposits. Test resistance value of H.S.I. if above 110 ohms (cold), replace with a lower resistance unit. Check respective positions – See Figure 13.2.

**Note:-** The H.S.I. element is very fragile.

A damaged or cracked burner should be replaced.

Replace components in reverse order using new gaskets.

## 11.8 Ignition Transformer

**Part No. 533901441**

Ensure that the boiler module electrical power supply is isolated before removing the front cover and gaining access to the controls.

Unplug the electrical connections to the transformer noting the orientation and relative positions. Remove the two pozi pan head screws securing the transformer to the control panel and withdraw. Fit the new unit in reverse order. Re-light the boiler and check for correct operation.

## 11.9 Main Control - LMU

<u>Part Number</u>		<u>Model</u>
Nat Gas	LPG	
533901658	533901659	- M100c
533901662	533901663	- M120c
533901664	533901665	- M150c
533901666	533901667	- M200c
533901668	533901669	- M250c
533901677	533901678	- M100c (30°C ΔT)
533901681	533901682	- M120c (30°C ΔT)
533901683	533901684	- M150c (30°C ΔT)
533901685	533901686	- M200c (30°C ΔT)
533901687	533901688	- M250c (30°C ΔT)

Ensure that the boiler module electrical power supply is isolated before removing the front cover and gaining access to the controls. Also ensure that all other supplies, particularly to the volt free contact outputs, are also isolated.

If a 'Clip in Module' is fitted, this must first be removed. Carefully disconnect the plug securing the clip in to the LMU - terminal X50, X40. Depress the locking latch at the connector end of the clip in to allow the module to be hinged up and disengaged from the LMU.

Unplug the electrical connections to the PCB noting the orientation and relative positions. Remove the 4 M5 nuts securing the controller to the control panel and withdraw.

Fit the replacement PCB in reverse order as described above. Remember to apply the parameters local to the installation on initialisation - refer to section 8 - Controls Operation. Re-light the boiler and check for correct operation.

### 11.10 Clip in Modules

**Part No. 533901438 - vfc relay output, 0~10v**

**AGU2.511A109**

**Part No. 533901456 - lpb communication**

**OCI420A109**

Ensure that the boiler module electrical power supply is isolated before removing the front cover and gaining access to the controls.

Carefully disconnect the plug securing the clip in module to the LMU - terminal X50, X40.

Carefully disconnect the plug from the top of the clip in module.

Depress the locking latch at the connector end of the clip in to allow the module to be hinged up and disengaged from the LMU.

Assemble in reverse order.

### 11.11 Display screen

**Part Number 533901437**

Ensure that the boiler module electrical power supply is isolated before removing the front cover and gaining access to the controls.

Carefully disconnect the ribbon cable connecting the screen to the LMU control, terminal X30. Remove the 4 screws securing the screen panel to the controls pod. Remove the 4 nuts securing the screen to the front panel of the controls fascia and remove the display pcb.

Remove the ribbon cable plug from the pcb and replace the display in reverse order.

### 11.12 Low Gas Pressure Switch

**Part No. 533901497 - 100c & 120c**

**Part No. 533925004 - 150c/200c/250c**

Ensure that the boiler module electrical power supply is isolated before removing the front cover and gaining access to the controls.

Isolate the boiler module gas supply by closing the gas service valve.

Disconnect the electrical plug after removing the securing screw.

Remove the screw(s) securing the switch to the gas valve body.

Fit the replacement switch in reverse order using new 'O' rings.

Set to correct pressure - refer to Appendix A.

### 11.13 Air Pressure Switch

**Part Number 532496004**

Ensure that the boiler module electrical power supply is isolated before removing the front cover and gaining access to the controls.

Disconnect the sensing tube from the switch noting the position. Disconnect the electrical connections noting their position. Remove the 2 screws securing the pressure switch body to the control bracket and remove the switch. Fit the replacement unit in reverse order.

### 11.14 Ignition Transformer In-line Fuse

**Part No. 533922013**

The boiler is equipped with an in-line fuse fitted between the ignition transformer and the main LMU. This T1A rated fuse can be located on the control panel once the front cover is removed. The condition of the fuse should be checked when a possible LMU malfunction has been diagnosed.

Fig. 11.4



In-Line Fuse

## 12.0 RECOMMENDED SPARES

**Please Note:-** To ensure the correct spare parts are despatched by our spares department, it is imperative that the complete Boiler/Module/Control Panel Serial Numbers are given. The Boiler and Module Serial Numbers are located on the Data Plates affixed to the combustion chamber front panel. The Electrical Serial Number is located inside the Control panel on the maximum power rating label. These numbers **MUST** be quoted when ordering spare parts.

<b>SPARES ITEM</b>	<b>PART No.</b>
<b>ELECTRICAL ITEMS</b>	
LMU control - 100c Nat Gas .....	533901658
LMU control - 100c LPG.....	533901659
LMU control - 120c Nat Gas .....	533901662
LMU control - 120c LPG.....	533901663
LMU control - 150c Nat Gas .....	533901664
LMU control - 150c LPG.....	533901665
LMU control - 200c Nat Gas .....	533901666
LMU control - 200c LPG.....	533901667
LMU control - 250c Nat Gas .....	533901668
LMU control - 250c LPG.....	533901669
LMU control - 100c Nat Gas (30°C ΔT).....	533901677
LMU control - 100c LPG (30°C ΔT).....	533901678
LMU control - 120c Nat Gas (30°C ΔT).....	533901681
LMU control - 120c LPG (30°C ΔT).....	533901682
LMU control - 150c Nat Gas (30°C ΔT).....	533901683
LMU control - 150c LPG (30°C ΔT).....	533901684
LMU control - 200c Nat Gas (30°C ΔT).....	533901685
LMU control - 200c LPG (30°C ΔT).....	533901686
LMU control - 250c Nat Gas (30°C ΔT).....	533901687
LMU control - 250c LPG (30°C ΔT).....	533901688
Display PCB.....	533901437
Ignition Transformer .....	533901441
Flow / Return Sensor.....	533901431
Temperature Limiter.....	533901179
Hot Surface Igniter .....	563801019
Flame Sensing Probe.....	533805019
Clip in Module - vfc + 0~10v - AGU2.511A109.....	533901438
Clip in Module - LPB Bus communication - OCI420A109.....	533901456
T1A Fuse 5x20.....	533922013
<b>MECHANICAL ITEMS</b>	
Burner Fabrication - 100c & 120c.....	533301019
Burner Fabrication - 150c.....	533301020
Burner Fabrication - 200c.....	533301021
Burner Fabrication - 250c.....	533301024
Gas Control Valve - 100c & 120c.....	533903037
Gas Control Valve - 150c/200c/250c.....	563903005
Combustion Fan - 100c & 120c.....	533704007
Combustion Fan - 150c/250c .....	533704003
Venturi - 100c & 120c .....	532418002
Venturi - 150c/200c/250c .....	532418001
Low Gas Pressure Switch - 100c & 120c.....	533901497
Low Gas Pressure Switch - 150c/200c/250c.....	533925004
Gas Orifice (LPG models 150c/200c/250c only).....	531101013
Air Pressure Switch.....	532496004
Descale Kit (condensing models).....	563605560
Gasket - Burner to heat exchanger.....	531201078
Gasket—Fan to burner.....	531201071
Gasket—View port.....	531201068
View Port Sight Glass.....	539907001
For service or spares please contact :-.....	
<b>Hamworthy Heating Limited</b>	<b>Phone Number..... 01202 662500</b>
<b>Wessex House</b>	<b>Fax Number..... 01202 662522</b>
<b>New Fields Business Park</b>	<b>Service..... 01202 662555</b>
<b>Stinsford Road</b>	<b>Spares..... 01202 662525</b>
<b>Poole, Dorset BH17 0NF</b>	<b>Technical..... 01202 662505</b>

## APPENDIX A - GAS DATA

GENERAL DATA	BOILER MODEL					
	100/100c		100/200c		100/300c	
Model - Condensing	Nat Gas	LPG	Nat Gas	LPG	Nat Gas	LPG
Boiler Input (maximum) - kW (Gross)	109.0	106.7	218.0	213.4	327.0	320.1
Boiler Input (maximum) - kW (Nett)	98.2	98.2	196.3	196.3	294.5	294.5
Boiler Output kW (maximum) condensing 50/30°C - kW	97.2	97.2	194.4	194.4	291.6	291.6
Boiler Output kW (maximum) non condensing 80/60°C - kW	95.7	95.7	191.4	191.4	287.1	287.1
Boiler Module Output (minimum) 80/60°C - kW	19.1					
Model - Condensing	120/120c		120/240c		120/360c	
	Nat Gas	LPG	Nat Gas	LPG	Nat Gas	LPG
Boiler Input (maximum) - kW (Gross)	133.0	130.2	266	260.4	399	390.5
Boiler Input (maximum) - kW (Nett)	119.8	119.8	239.5	239.5	359.3	359.3
Boiler Output kW (maximum) condensing 50/30°C - kW	116.2	116.2	232.5	232.5	348.7	348.7
Boiler Output kW (maximum) non condensing 80/60°C - kW	115.2	115.2	230.4	230.4	345.6	345.6
Boiler Module Output (minimum) 80/60°C - kW	23.5					
Model - Condensing	150/150c		150/300c		150/450c	
	Nat Gas	LPG	Nat Gas	LPG	Nat Gas	LPG
Boiler Input (maximum) - kW (Gross)	163.0	159.5	326	319.1	489	478.6
Boiler Input (maximum) - kW (Nett)	146.8	146.8	293.6	293.6	440.3	440.3
Boiler Output kW (maximum) condensing 50/30°C - kW	147.4	147.4	294.8	294.8	442.2	442.2
Boiler Output kW (maximum) non condensing 80/60°C - kW	142.8	142.8	285.6	285.6	428.4	428.4
Boiler Module Output (minimum) 80/60°C - kW	28.7					
Model - Condensing	200/200c		200/400c		200/600c	
	Nat Gas	LPG	Nat Gas	LPG	Nat Gas	LPG
Boiler Input (maximum) - kW (Gross)	219.0	214.4	428.7	394.4	657	643.1
Boiler Input (maximum) - kW (Nett)	197.2	197.2	394.4	394.4	591.6	591.6
Boiler Output kW (maximum) condensing 50/30°C - kW	196.3	196.3	392.6	392.6	588.9	588.9
Boiler Output kW (maximum) non condensing 80/60°C - kW	191.6	191.6	383.2	383.2	574.8	574.8
Boiler Module Output (minimum) 80/60°C - kW	38.6					
Model - Condensing	250/250c		250/500c		250/750c	
	Nat Gas	LPG	Nat Gas	LPG	Nat Gas	LPG
Boiler Input (maximum) - kW (Gross)	275.0	269.2	550	538.3	825	807.5
Boiler Input (maximum) - kW (Nett)	247.6	247.6	495.3	495.3	742.9	742.9
Boiler Output kW (maximum) condensing 50/30°C - kW	254.4	254.4	508.7	508.7	763.1	763.1
Boiler Output kW (maximum) non condensing 80/60°C - kW	239.8	239.8	479.6	479.6	719.4	719.4
Boiler Module Output (minimum) 80/60°C - kW	48.4					
GAS DATA	100c	120c	150c	200c	250c	
Gas Inlet Connection Pipe Thread Size	R1"		R1 1/4"			
Nominal Inlet Pressure Nat Gas (LPG) -mbar	20 (37)					
Maximum Inlet Pressure Nat Gas (LPG) -mbar	25 (45)					
Gas Pressure Switch Setting Nat Gas (LPG) -mbar	12.5 (20)					
Gas Flow Rate (max. per module) Nat Gas -m <sup>3</sup> /h	10.4	12.7	15.5	20.9	26.2	
Gas Flow Rate (max. per module) LPG -m <sup>3</sup> /h	4.0	4.9	6.0	8.1	10.1	
Target CO <sub>2</sub> % at High / Low fire Nat Gas ±0.25%	9.0					
Target CO <sub>2</sub> % at High / Low fire LPG ±0.25%	10.6					
NO <sub>x</sub> emission at 0% O <sub>2</sub> (dry) Nat Gas mg/kWh	39.8	34.3	37.7	39.9	38.8	
NO <sub>x</sub> emission at 0% O <sub>2</sub> (dry) LPG mg/kWh	42.0	58.1	69.3	68.6	39.9	

## **APPENDIX B - ELECTRICAL CONNECTIONS AND CONTROLS**

<b>ELECTRICAL DATA</b>		
Model	100/100c 120/120c	150/150c 200/200c 250/250c
Normal Supply Voltage	230V ~ 50Hz	
Power Consumption (maximum per module) -W	170	250
Start / Run Current (per module) -A	1.2 / 0.8	1.3 / 0.9

### **B1.1 Electrical Supply**

**IMPORTANT: Individual boiler modules must be earthed.**

**The boiler must be isolated from the mains electricity supply in the event of electric arc welding being carried out on any connecting pipework.**

1. Wiring external to the boiler must be installed in accordance with the IEE Regulations and any local regulations which apply. Wiring must be completed in heat resistant 3-core cable of 1.0mm<sup>2</sup> cross sectional area. Boilers are normally supplied for connection to a 230 volts, 50Hz mains supply. The LMU is supplied with a replaceable fuse (T6.3A). External fuses should be 10A for all boiler modules.
2. 3-Phase Electrical Supplies. Individual modules of ModuMax boilers and boilers installed in close proximity to each other **MUST NOT** be supplied from different phases of a 3 phase supply. The method of connection to the mains electricity supply must facilitate complete electrical isolation of the single boiler / battery with a separation of at least 3mm in all poles.
3. A mains isolator must be provided adjacent to the boiler in a readily accessible position. The supply should only serve the boiler.
4. 2 & 3 high stacked modules. It is highly recommended that each boiler module is connected via its own mains isolator to facilitate servicing and maintenance of the individual boiler modules whilst leaving the remaining modules in operation. For typical schematic please refer to figure B1.2 on the next page.
5. Volt free contact electrical supplies must be isolatable where fitted.
6. Further details regarding connection to the electricity supply are given in BS EN 60335, Part 1 or BS 3456, Part 201.

**WARNING: THE MAINS POWER SUPPLY MUST NOT BE SWITCHED BY A TIME-CLOCK CONTROL.**

**CAUTION: DO NOT FEED MAINS VOLTAGE ONTO THE TIMER TERMINALS**

7. The mains power supply must be maintained at all times. Each Wessex ModuMax boiler module incorporates a remote stop/start loop, which can be used to operate the boiler(s) under a timed regime. The boiler controls provide a 24V DC signal that can be fed through a volt free contact for operation. Refer to BS 6644 for further information on installing the electrical supply.

**NOTE:  
FOR ELECTRICAL CONNECTIONS TO BOILER SEE FIGURE 4.5  
FOR BOILER WIRING SCHEMATIC SEE FIGURE 9.0  
FOR MULTIPLE BOILER WIRING SEE FIGURE B1.2 & B1.3  
FOR CONTROL WIRING SEE FIGURE E1.3.1 TO E1.3.4**



**Figure B1.2 - External Control Wiring for Multiple Module Installation**

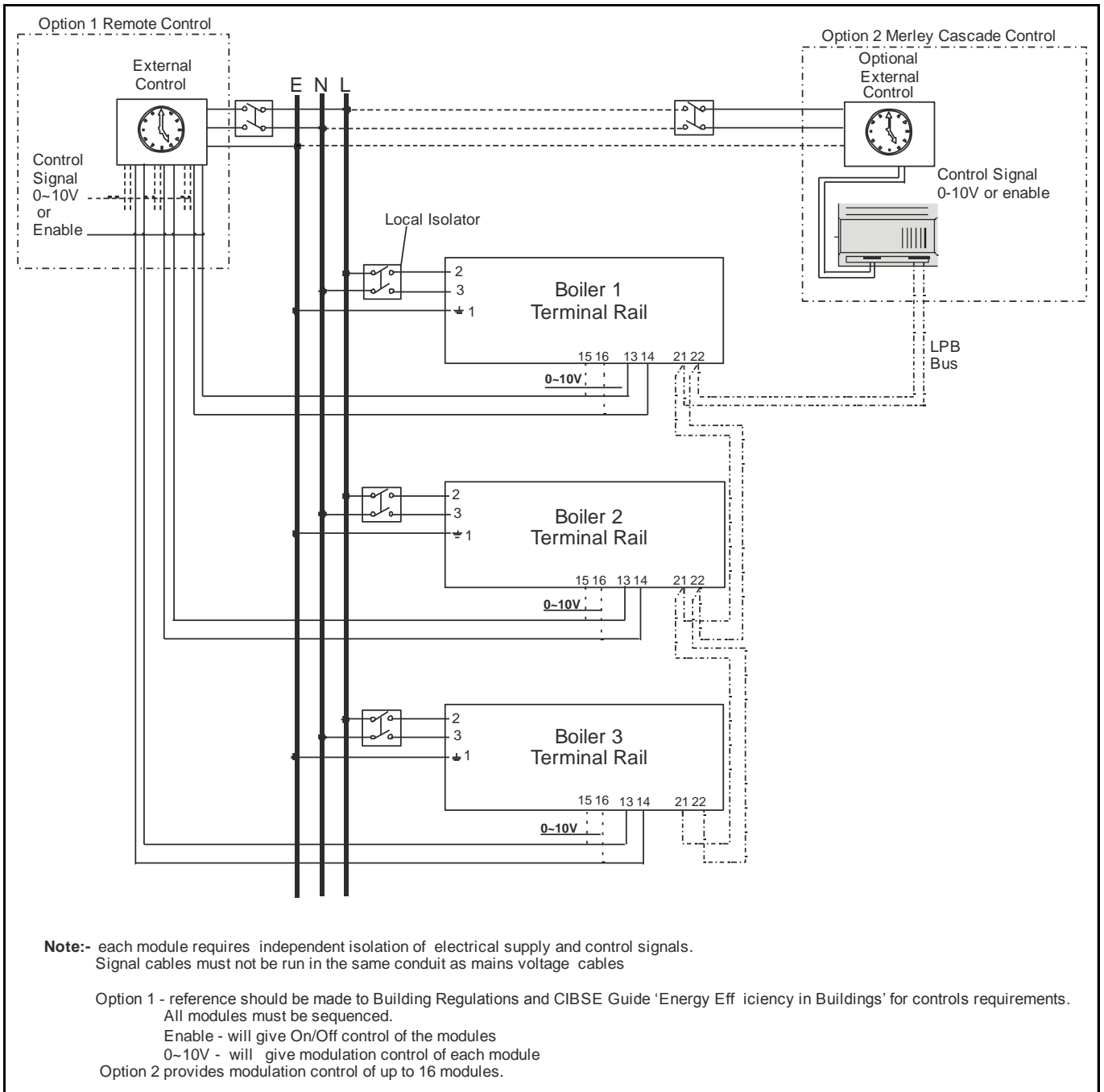

## APPENDIX C - FLUE DATA

### Natural Gas & LPG

FLUE DATA - Natural Gas		100c			120c			150c		
Model - Condensing		100c	200c	300c	120c	240c	360c	150c	300c	450c
Nominal Flue Diameter-	mm	100	180	180	100	180	180	150	250	250
Maximum Flue Gas Temperature-	°C	83			83			78		
Pressure at the boiler flue outlet-	Pa/mbar	150 / 1.5			150/1.5			89 / 0.89		
Approx. Flue Gas Volume	m <sup>3</sup> /h*	143	286	429	160	320	480	214	428	642
		200c			250c					
Model - Condensing		200c	400c	600c	250c	500c	750c			
Nominal Flue Diameter-	mm	150	250	250	150	250	250			
Maximum Flue Gas Temperature-	°C	83			82					
Pressure at the boiler flue outlet-	Pa/mbar	90 / 0.9			150 / 1.5					
Approx. Flue Gas Volume	m <sup>3</sup> /h*	279	558	837	354	708	1062			

\* **Note:-** Flue gas volumes are corrected to a flue gas temperature of 15°C, @ 9.1% CO<sub>2</sub> and barometric pressure of 1013.25mbar.

### C1.0 FLUE SYSTEM

1. Detailed recommendations for flue systems are given in BS 6644, and IGE/UP/10. All flue discharges for plant exceeding 150kW output must comply with the third edition of the 1956 Clean Air Act Memorandum.

**WARNING: THE FLUE DISCHARGE FROM A MODUMAX BOILER WILL GENERATE A PLUME AT THE TERMINAL EXIT. THIS MUST BE CONSIDERED WITH REGARD TO TERMINAL LOCATION AND ADJACENT BUILDING FABRIC.**

### C1.1 General Requirements

The Hamworthy Wessex ModuMax series of boilers are designed to be used with natural draught flues or a room sealed twin duct system supplied by Hamworthy Heating for 100c & 120c single boiler installations only. Flue systems should be designed in accordance with regulations and with reference to BS 6644 and IGE/UP/10.

#### Open (Natural draught ) Flue.

Type B23: Intake from ventilated plant room and discharge via horizontal/vertical flue. – Fig C1.1.2

The connection to the boiler is suitable for 100mm flue duct (100c & 120c) & 150mm flue duct (150c/200c/250c), for connection to an open flue (chimney) system . The resistance of the flue system components is detailed in Figure C1.1.1

The following points should be noted:

- Due to the high thermal efficiency of the boiler condensation in the flue will occur. It is strongly recommended that twin wall or insulated flue pipe is used on all installations.
- Care should be taken to ensure that the flue is installed such that any condensation is continuously drained. All flues should have a maximum slope of 2° upwards in the direction of the exhaust gas flow (no horizontal sections). All joints should be such that any condensation is directed back down the slope to an open drain connection in the flue. The drain pipe must be manufactured from a corrosion resistant material and be at least 15mm diameter. It must also have a fall of at least 2-3° (approx. 30-50mm per meter) and connect to a drain via a waste trap.
- Boiler flue outlet sizes - A flue system designed with the same diameter as the boiler flue outlet may not provide satisfactory performance in all applications. Conversely a flue system designed with a smaller diameter than the boiler flue outlet may provide satisfactory performance. Consideration must be given to the correct calculation of the required flue size. If in any doubt consult Hamworthy Heating Ltd who can supply a full flue design and installation service.

The following points should be noted:

Room Sealed Flue: Refer to Figures C1.1.2 & C1.1.3 for details. The system is not intended as a balanced flue and air inlet and flue terminals must be separated by at least 700mm.

### **C1.2 Waste Gas Volume and Temperature.**

It is recommended that the volume and temperature of the waste gases used for design of the flue system are as given in the above tables.

### **C1.3 Materials.**

Materials used for the flue system must be mechanically robust, resistant to internal and external corrosion, non-combustible and durable under the conditions to which they are likely to be subjected. Consideration must be given to avoid possible freezing of condense water traps and pipework

**WARNING: THE FLUE SYSTEM MUST BE SELF SUPPORTING AND NOT PRESENT  
A RISK TO PEOPLE IN OR AROUND THE BUILDING.**

### **C1.4 Suction**

The maximum number of Modules firing into a common chimney is 9. (IM11/IGEUP10 states 8 for a natural draft flue). For larger installations refer to HHL Technical.

The flue system referred to in Table C1.1 must be designed acknowledging that there is a positive pressure generated by the boiler combustion fan. It is recommended that a draught stabiliser is fitted to the flue system where the suction is likely to be negative at the boiler connection. Any stabiliser fitted must be in or close to the vertical chimney.

The flue system must be designed to limit the **maximum suction (cold)** to **30Pa negative**, measured at the connection to the boiler. Should the suction be greater than 30Pa, refer to HHL technical.

This condition must then be checked **Hot** and with all boilers firing, the maximum pressure condition at the connection to the boiler is **150Pa positive**.

In the event that the flue system when **Hot** does generate a suction, the **maximum suction is 100Pa**.

**Fan Dilution** - The design must provide for the use of balancing and trim dampers, and their location and operation must be such that the constraints detailed above can be met. Care must be taken to ensure that the fan performance is matched to deliver the appropriate dilution, whilst ensuring that excessive suction is not applied to the boilers. If in doubt, refer to HHL Technical.

**Fan assist** - The use of fan assist must only be a last resort as the boilers have sufficient fan performance to drive the system. If in doubt, refer to HHL Technical.

### **C1.5 Disconnection**

Provisions should be made for disconnection of the flue pipe for servicing. It is advisable that bends are fitted with removable covers for inspection and cleaning as appropriate.

## C1.6 Flue Discharge

The flue system must ensure safe and efficient operation of the boiler to which it is attached, protect the combustion process from wind effects and disperse the products of combustion to the external air. The flue must terminate in a freely exposed position and be so situated as to prevent the products of combustion entering any opening in a building. Where the flue diameter is less than 204mm (8") diameter a terminal must be fitted. Where the flue is of a larger size, consideration should be given to the fitting of a flue discharge terminal or grille to stop ingress of birds etc.

## C1.7 Surface Temperatures

**Figure C1.1.1 Flue Resistance**

Model	Flue Dia. (mm)	Max Flue Length (m)	Equivalent Length (m) 90°	Equivalent Length (m) 45°
100/100c 120/120c	100	15	1.5	1.2
150/150c	150	43	2.4	1.8
200/200c		22		
250/250c		28		
100/200c	180	101	2.8	2.1
100/300c		41		
120/240c	180	85	2.9	2.2
120/360c		35		
150/300c	250	163	4.4	3.4
150/450c		69		
200/400c		94		
200/600c		36		
250/500c	250	110	4.6	3.5
250/750c		44		

Combustible materials in the vicinity of the boiler and flue shall not exceed 65°C during boiler operation. The flue shall not be closer than 50mm to any combustible material, except where it passes through such material with a non-combustible sleeve when the air gap may not be less than 25mm.

### C1.8 Location

The flue system must not be placed or fitted where there is undue risk of accidental damage to the flue pipe or undue danger to persons in the vicinity. Check that the flue and chimney are clear from any obstruction. Wessex ModuMax boilers are suitable for installation in a balanced compartment in accordance with the requirements of BS 6644. Consult Hamworthy Heating Technical Department for help or assistance if in doubt.

### C1.9. Condensate Discharge

Due to the high thermal efficiency of the boiler, condensation will occur within the boiler casing during firing from cold conditions. A drain with an integral trap is fitted to the rear of each module suitable for connection to a 32mm plastic waste

pipe (not Hamworthy Heating Ltd supply), which must be connected to a tundish (not Hamworthy Heating Ltd supply). Discharge piping from a tundish should be of synthetic material due to the mild acidity of the condensate (pH3-5), with all discharge piping having a minimum fall of 30mm/m away from the boiler. Consideration should be given to possible freezing of condense water traps and pipework. This must be avoided at all times by routing pipework within the building, where possible. In addition to the above the stacked module arrangement flue boxes are supplied with a trap terminating in a 32mm i.d. connection, which should be connected in a similar manner to a drain.

**Figure C1.1.2 - Open Natural Draught (B23) Flue System - applies to 100c & 120c single boilers only**  
**Figure C1.1.2 - Open Natural Draught (B23) Flue System (Multiple Boiler Installations)**

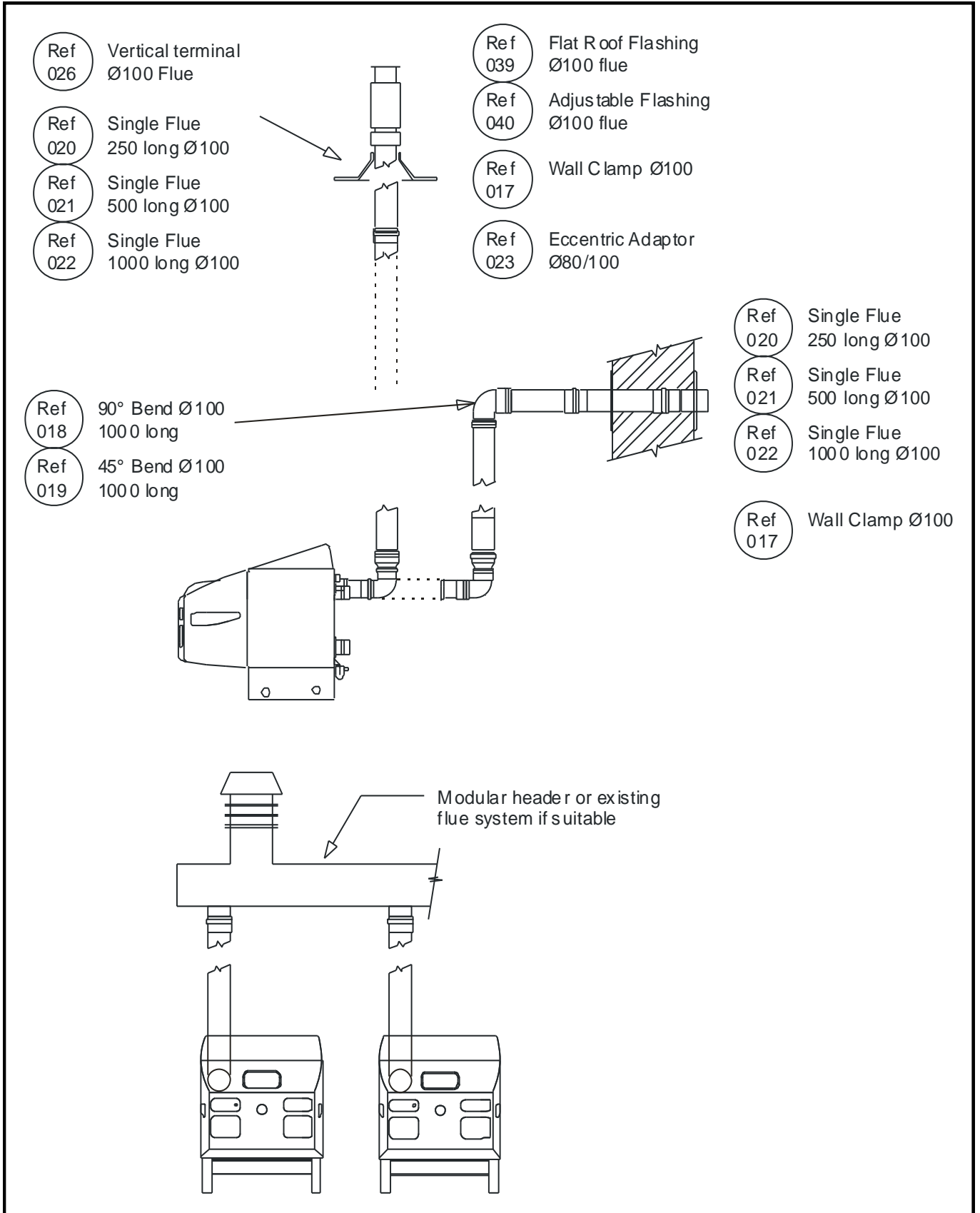

**Figure C1.1.3 - Room Sealed B53 Flue Systems - applies to 100c & 120c single boiler installations only.**

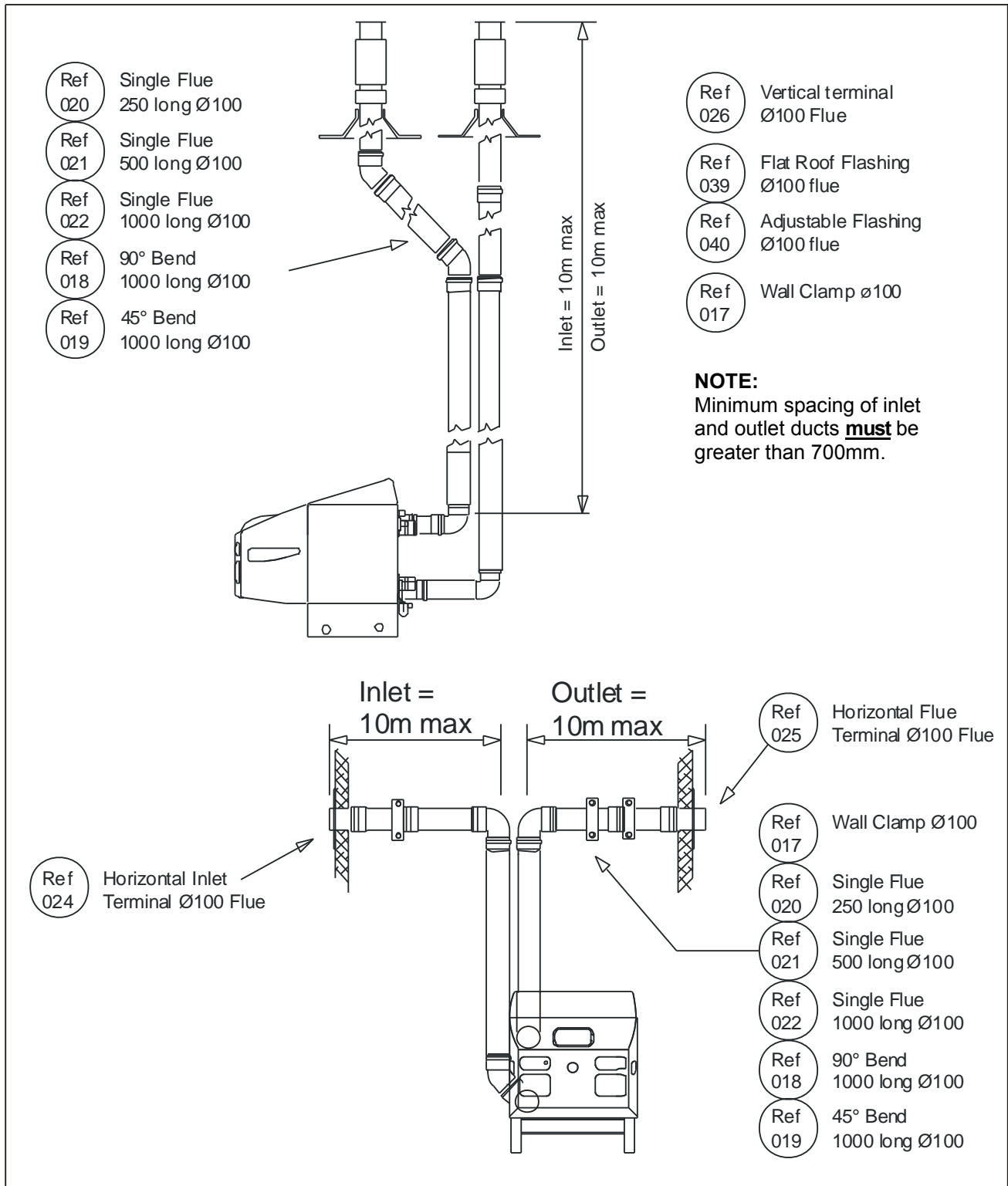

**Connection of 100mm dia. Ducts — Horizontal/Vertical Room Sealed and Open Flue Systems**

Refer to Figure C1.1.3. Fit the flue components on route to the terminal discharge taking care not to damage the flue seal when assembling the flue components, and ensuring a minimum 2° slope and that the flue system is self supporting using wall brackets where necessary. In terminating the flue system, ensure that the joint through the wall / roof is made good and weatherproofed.

**Important - In fitting the HHL supplied 100mm dia. Ducts to a stainless steel flue system, the flue system must have it's own condense drain. The system must not be allowed to drain back through the HHL supplied components.**

## **APPENDIX D - VENTILATION**

### **D1.1 Air Supply**

Detailed recommendations for air supply are given in BS 6644 and BS5440 Pt 2. The following notes are intended to give general guidance. In all cases there must be provision for an adequate supply of air for both combustion and general ventilation, in addition to that required for any other appliance.

**Note:** For Open flue applications, combustion air for the boiler is drawn through the top of the boiler casing. The air inlets **must** be kept open and free from blockage at all times.

**LPG - installations. It is strongly recommended that gas detection equipment is fitted. This equipment should be positioned near the boiler(s) and at low level. The space housing the boiler(s) must be ventilated at high and low level in accordance with the following;**

#### **D1.2.1 Air Supply by Natural Ventilation - Open Flue applications**

The boiler room must have, or be provided with, permanent air vents directly to the outside air, at high level and at low level. For an exposed boiler house, air vents should be fitted, preferably on all four sides, but at the least on two sides. Air vents should have negligible resistance and must not be sited in any position where they are likely to be easily blocked or flooded or in any position adjacent to an extraction system which is carrying flammable vapour. Grilles or louvres must be so designed that high velocity air streams do not occur within the space housing the boiler.

##### **Boiler house ventilation**

Low level (inlet) - 4cm<sup>2</sup> per kW of total rated input (Net)  
High level (output) - 2cm<sup>2</sup> per kW of total rated input (Net)

##### **Compartment ventilation**

Where the boiler is to be installed in a cupboard or compartment, permanent high and low level ventilation is required which must communicate direct to outside, for cooling purposes.

Low level (inlet) - 10cm<sup>2</sup> per kW of total rated input (Net)  
High level (output) - 5cm<sup>2</sup> per kW of total rated input (Net)

#### **D1.2.2 Air Supply by Natural Ventilation - Room Sealed Installations**

Where the boiler(s) are to be installed in a boiler room or internal space, the room or internal space must have permanent air vents directly to the outside air, at high level and at low level with the general requirements detailed above on location and construction.

##### **Boiler house ventilation**

Low level (inlet) - 2cm<sup>2</sup> per kW of total rated input (Net)  
High level (output) - 2cm<sup>2</sup> per kW of total rated input (Net)

##### **Compartment ventilation**

Where the boiler is to be installed in a cupboard or compartment, permanent high and low level ventilation is required which may communicate to an adjoining room or outside, for cooling purposes.

Ventilation to a room or internal space - 10cm<sup>2</sup> per kW of total rated input (Net)  
Ventilation direct to outside - 5cm<sup>2</sup> per kW of total rated input (Net)

### D1.3 Air Supply by Mechanical Ventilation

Air supplied to the boiler room by Mechanical means should be as follows:

- 1) Mechanical ventilation must be interlocked with the boilers to prevent operation in the event of ventilation fan failure
- 2) Mechanical inlet and mechanical extract can be utilised providing the design extraction rate does not exceed one third of the design inlet rate.
- 3) Mechanical extract ventilation with natural inlet ventilation **MUST NOT** be used.

For Mechanical ventilation systems an automatic control should be provided to cut off the gas supply to the boiler, in the event of failure of air flow in either inlet or extract fans.

### D 1.4. Boiler House Temperatures

The air supplied for boiler house ventilation shall be such that the maximum temperatures within the boiler house shall be as follows:

At floor level (or 100mm above floor level) = 25°C.

At mid-level (1.5m above floor level) = 32°C.

At ceiling level (or 100mm below ceiling level) = 40°C.

### D 1.5. General Requirements

The air supply should be free from contamination such as building dust and insulation fibres from lagging. To avoid unnecessary cleaning and servicing of the boiler modules, the boilers should not be fired whilst building work is being undertaken.

High and low level ventilation grilles shall be positioned as high and as low as practicably possible. Low level grilles should be located within 1 metre of the floor for Natural Gas and within 250mm of the floor for LPG. High level grilles should be positioned within 15% of the boiler room height from the ceiling. High and low level grilles shall communicate with the same room or space where compartment ventilation is used. Where grilles communicate directly with outside air, they shall be positioned on the same wall.

**Figure D1 Mechanical Ventilation Flow Rates**

Boilers Without Draught Diverters	Flow rate per kW total rated heat input (net)	
	Inlet air (Combustion ventilation)	Difference between inlet and extract air (Inlet minus extract ventilation)
	m <sup>3</sup> /h	m <sup>3</sup> /h
	2.6	1.35 +/- 0.18

Note \* : Where the associated air extraction is also by means of a fan, this shall be selected such as not to cause a negative pressure to develop in the boiler house and to maintain the difference between inlet and extract flow rates shown above.

The calculated extract flow rate is the actual inlet flow rate minus the appropriate figure in the table above.



## APPENDIX E - WATER DATA

**Table E1.1—Water Data**

Model	100 /100c	120/120c	150/150c	200/200c	250/250c
Water Connections (Flow & Return)	G 1½" male		G 2½" male		
Maximum Water Pressure (bar g)	10				
Water Content (litres) -excluding headers	16	16	22	22	22
System Design Flow Rate (litres/s) @ 11°C ΔT Rise	2.2	2.6	3.3	4.3	5.4
System Design Flow Rate (litres/s) @ 20°C ΔT Rise	1.2	1.4	1.8	2.4	3
System Design Flow Rate (litres/s) @ 30°C ΔT Rise	0.8	1.0	1.2	1.6	2.0
Waterside Pressure Loss (mbar) @ 11°C ΔT Rise	61	91	500	850	1300
Waterside Pressure Loss (mbar) @ 20°C ΔT Rise	20	27	145	246	395
Waterside Pressure Loss (mbar) @ 30°C ΔT Rise	9	14	60	120	180
Minimum flow temperature setting	30°C @ 11°C ΔT 30°C @ 20°C ΔT 40°C @ 30°C ΔT				

### E1.1 Water Circulation System

The Wessex ModuMax boiler has a low water content and the requirements of minimum water flow are given in the above table. Recommendations for the water circulation system are given in BS 6644 and CP 342.

The following details are of particular importance for the correct installation of the water circulation system:

- 1) In a combined central heating and hot water system the hot water storage vessel must be of the indirect cylinder or calorifier type. The hot water storage vessel should be insulated, preferably with not less than 75mm (3") thick mineral fibre, or its thermal equivalent.
- 2) Circulating pipework not forming part of the useful heating surface should be insulated to help prevent heat loss and possible freezing, particularly where pipes are run through roof spaces and ventilated cavities. Cisterns situated in areas which may be exposed to freezing conditions should also be insulated. Furthermore, insulation exposed to the weather should be rendered waterproof.
- 3) Drain valves must be located in accessible positions which permit the draining of the whole system, including the boiler and hot water storage vessel.
- 4) Each boiler module has G1½ or G2½ (refer to Table E1.1) male flow (indicated with a red spot) and return (indicated with a blue spot) connections. Boilers should be connected by flow and return headers. Headers should be connected to the system in a 'reverse / return' arrangement (the water flow in each header is in the same direction) to ensure equal flow in each module, or with a 'single pipe header system'. Figure E1.1.1 on the following page show typical layouts.
- 5) Ideally, individual valves should be fitted to each module to enable isolation from the system, however, the arrangement must comply with the requirements of BS 6644.

## **E1.2 Minimum System Water Pressure**

To comply with guidance note **PM5 (Health and Safety Executive)**, the minimum pressure requirements at the boiler are given below as examples:-

- 1) Single installed boiler running at 82°C flow temperature. Minimum head required is not less than 2.0 metres or 0.2 bar.
- 2) Single installed boiler running at 90°C flow temperature. Minimum head required = 3.0 metres or 0.30 bar.
- 3) Modular boiler installation running at 82°C flow temperature and 11°C rise across system.  
Minimum head required = 4.4 metres or 0.43 bar.
- 4) Modular boiler installation running at 82°C flow temperature and 15°C rise across system.  
Minimum head required = 6.5 metres or 0.64 bar.

## **E1.3 Pressure Relief Valve (Safety Valve)**

The most important single safety device fitted to a boiler is its safety valve. Each boiler module is provided with a capped R<sup>3</sup>/<sub>4</sub>" stub pipe for the fitting of a safety valve (not supplied). BS 6644 provides comprehensive information for the selection and location of safety valves and attention is drawn to the higher capacity requirements of safety valves for pressurised hot water systems.

**Figure E1.1.1 - Typical Piping Layouts**

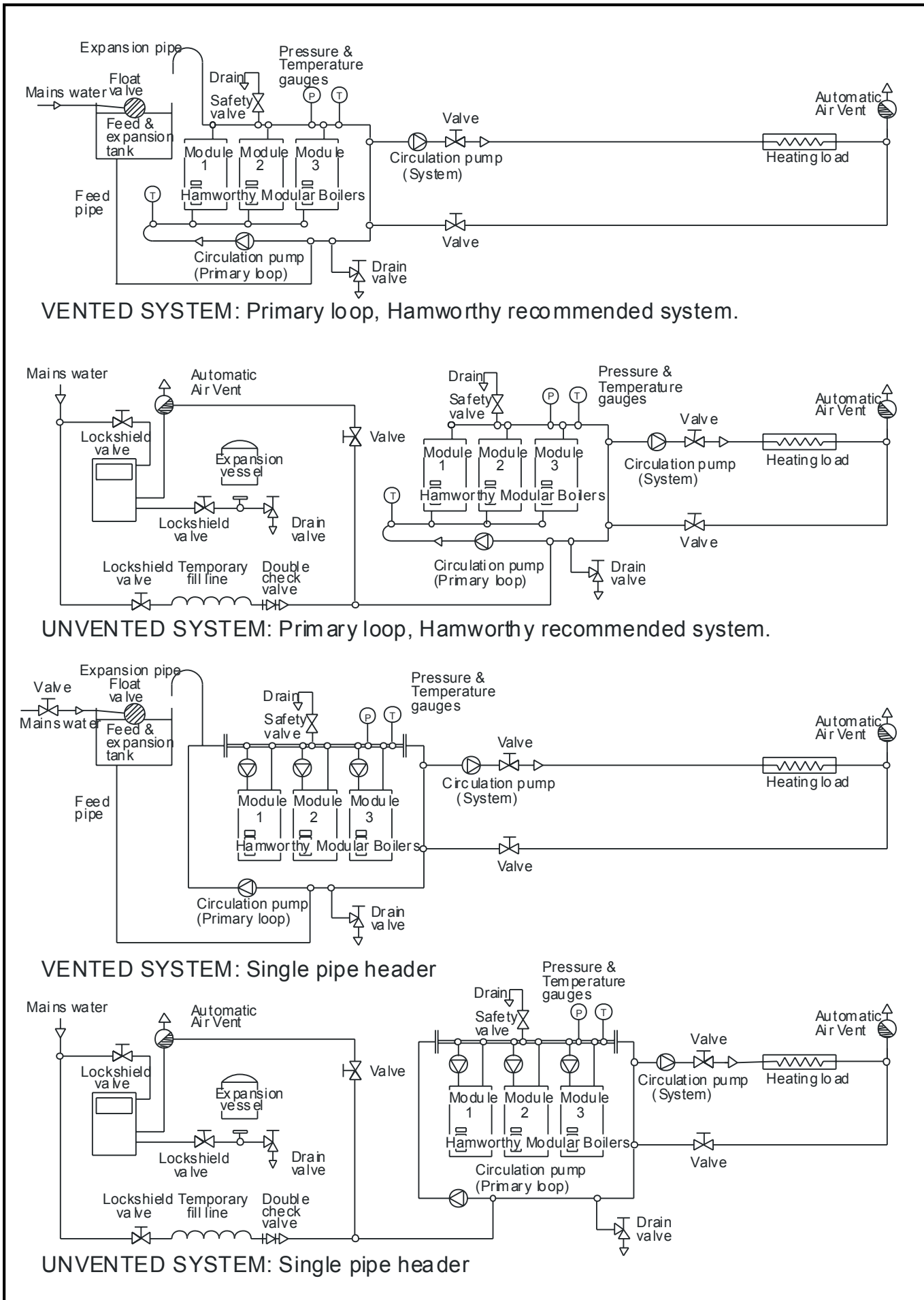

**Figure E1.3 Cold Feed and Vent Pipe Sizes**

<b>Boiler Output</b>	<b>Feed mm</b>	<b>Vent mm</b>
60 - 150kW	25	32
150 - 300 kW	32	38
300 - 600 kW	38	50
>601 KW	50	65

**E1.4 Open Vent and Cold Feed Pipe.**

Every boiler or group of boilers should have an open vent pipe and cold feed pipe installed between the boiler and the first water isolating valve. The minimum bore (mm) of these pipes per installation is shown in the table. The vent pipe must rise continually, any valve fitted between a boiler and the open vent pipe for maintenance purposes shall be of the 3 way type such that when closed to the vent pipe the boiler will be open to atmosphere. The vent pipe shall be protected against freezing where this might occur. See BS 6644 for detailed information on Open Vent and Cold Feed Pipes.

**E1.5 Altitude Gauge (Water Pressure Gauge)**

Every boiler or group of boilers should be provided with an altitude gauge complete with isolating valve. See Figure E1.1.1 for typical position.

**E1.6 Thermometer**

A thermometer complete with pocket should be fitted in the pipework to indicate water flow temperature. See Figure E1.1.1 for typical position.

**E1.7 Drain Valves**

Each boiler should have a 15mm NB drain valve (not Hamworthy Heating Ltd supply) fitted in the boiler return to drain the boiler only. The heating system in total should have drain valves as recommended by BS 6644. See Figure E1.1.1 for typical position.

**E1.8 Circulating Pump**

One or more circulating pumps will be required to circulate water around the boilers and heating system. The pump should be sited to facilitate servicing. It is important that when Wessex ModuMax boilers are used to replace boilers on an existing system, the pumps should be checked for performance against the new boiler waterside pressure loss to ensure that the minimum flow rate can be obtained. It is also important that the existing system be flushed through twice to remove any loose matter which may have accumulated. If in any doubt regarding the cleanliness of the system, a coarse filter should be fitted in the return pipework to the boilers.

If boilers are run off time clock control a pump overrun (not Hamworthy Heating Ltd supply) should be fitted which must run for a minimum of 5 minutes on shutdown of the last boiler.

**E1.9 Minimum Water Flow Rates**

Minimum water flow rates are shown in table at beginning of Appendix E. These flow rates should be maintained through the boiler at all times whilst the boiler is firing. If the water flow rate is allowed to fall below the minimum the boiler heat exchanger could fail due to the resultant scale formation. Particular attention should be paid to the restriction of external flow circuits during periods of low heat demand.

**E1.10 Waterside Pressure Drop**

The waterside hydraulic resistance (Pressure drop) is given in table at beginning of Appendix E.

**E1.11 Water Flow Controls**

Any external mixing valve / shunt pump or similar controls MUST always ensure that the minimum water flow rate as given in table at beginning of Appendix E is maintained. If there is any doubt relating to site flow conditions it is suggested that a flow switch is fitted. The flow switch should be connected such that the boiler will shut down if insufficient flow occurs.

**E1.12 Frost Protection**

Consideration should be given to fitting a frost thermostat set at approximately 4°C.

### E1.13 Unvented Systems

Refer to Figure E1.1.1 on opposite page for typical layout of an unvented (Pressurised) Hot Water System. For system design refer to BS 7074 Part 2. In order to correctly size a pressurisation unit for any heating system the following parameters are required.

- 1) Static height of highest component in system (metres)
- 2) System volume. If this is not known, a general rule of thumb of 10litres/kW of installed boiler power can be used.
- 3) Maximum flow temperature (°C)
- 4) Maximum system hot working pressure, generally given in bar gauge.

From the parameters given, Hamworthy Heating can size the pressurisation unit and also the expansion vessel required.

Care must be taken in sizing expansion vessels to ensure maximum acceptance factors are not exceeded. Normally manufacturers of vessels impose a limit of 0.5. This value must not be exceeded at any time during the operation of the boiler, this includes the over pressure condition should a safety valve lift.

Consideration should also be given to sizing of the safety valve(s) in the system. Refer to BS 6759: Part 1 for further information and to BS 6880: Part 1 for design considerations.

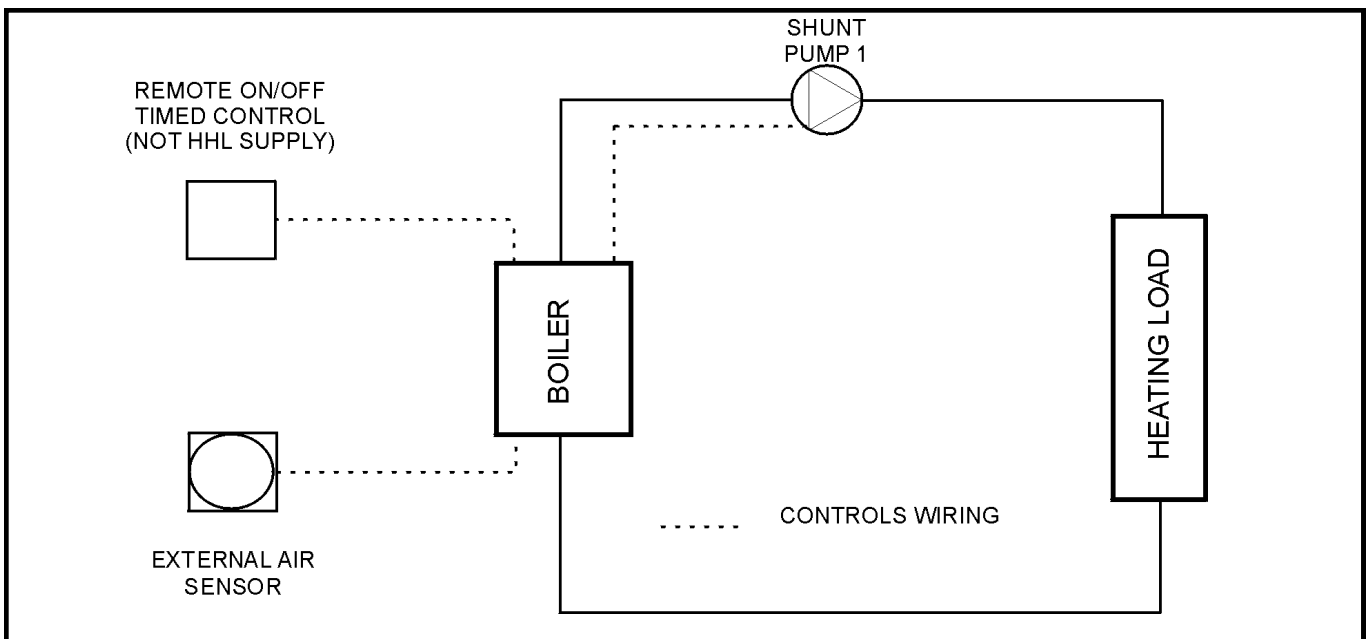

**Figure E 1.3.1 - Schematic for Single Boiler System**

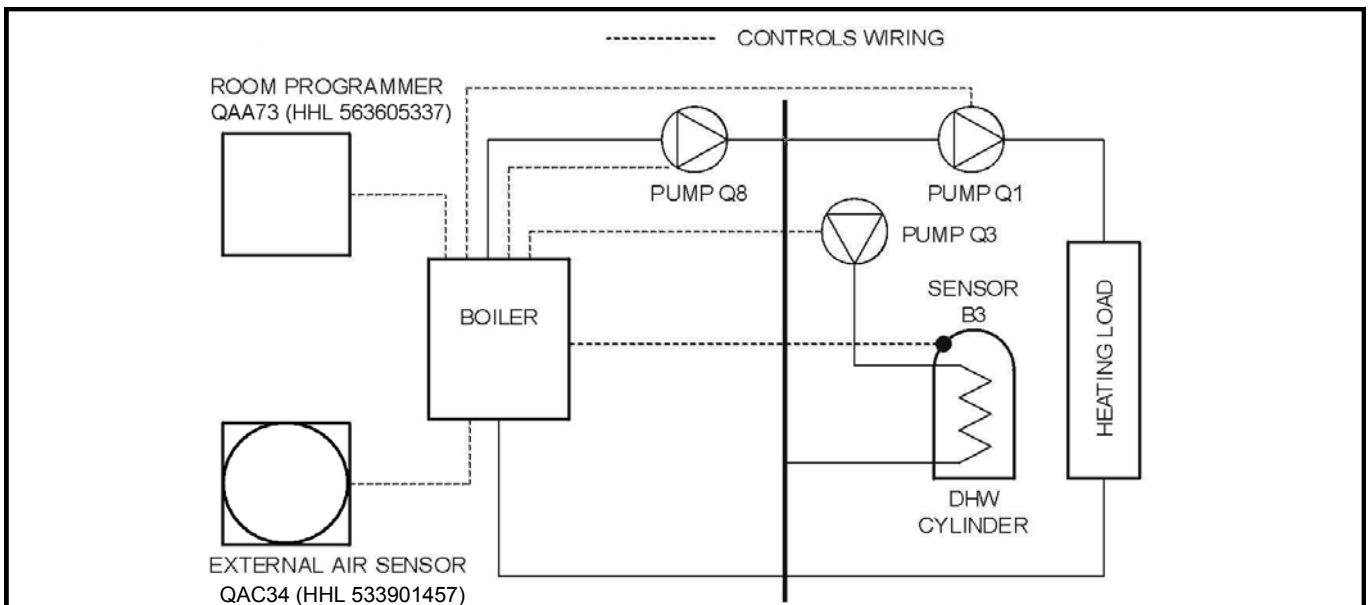

**Figure E 1.3.2 - Schematic for Single Boiler, Primary Circuit System**

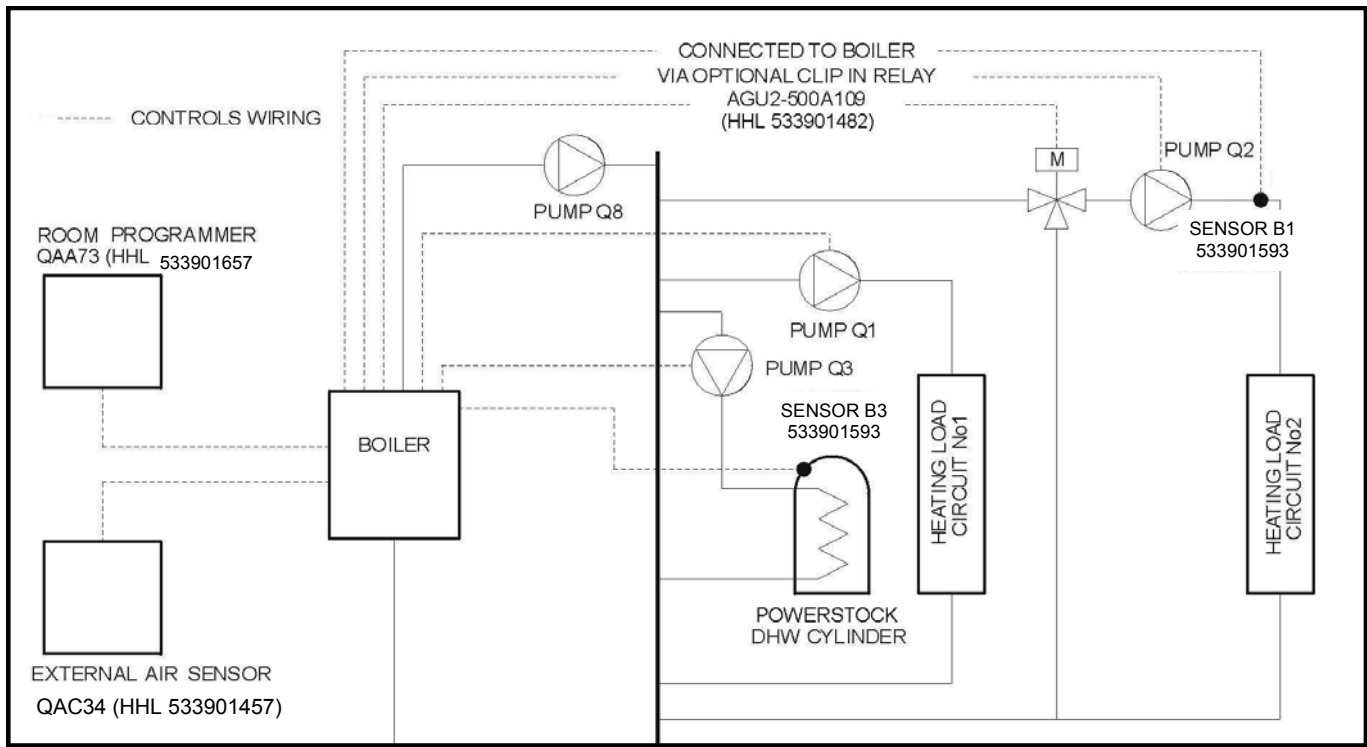

**Figure E 1.3.3 - Schematic for Single Boiler (External 0~10V), Multi Circuit System**

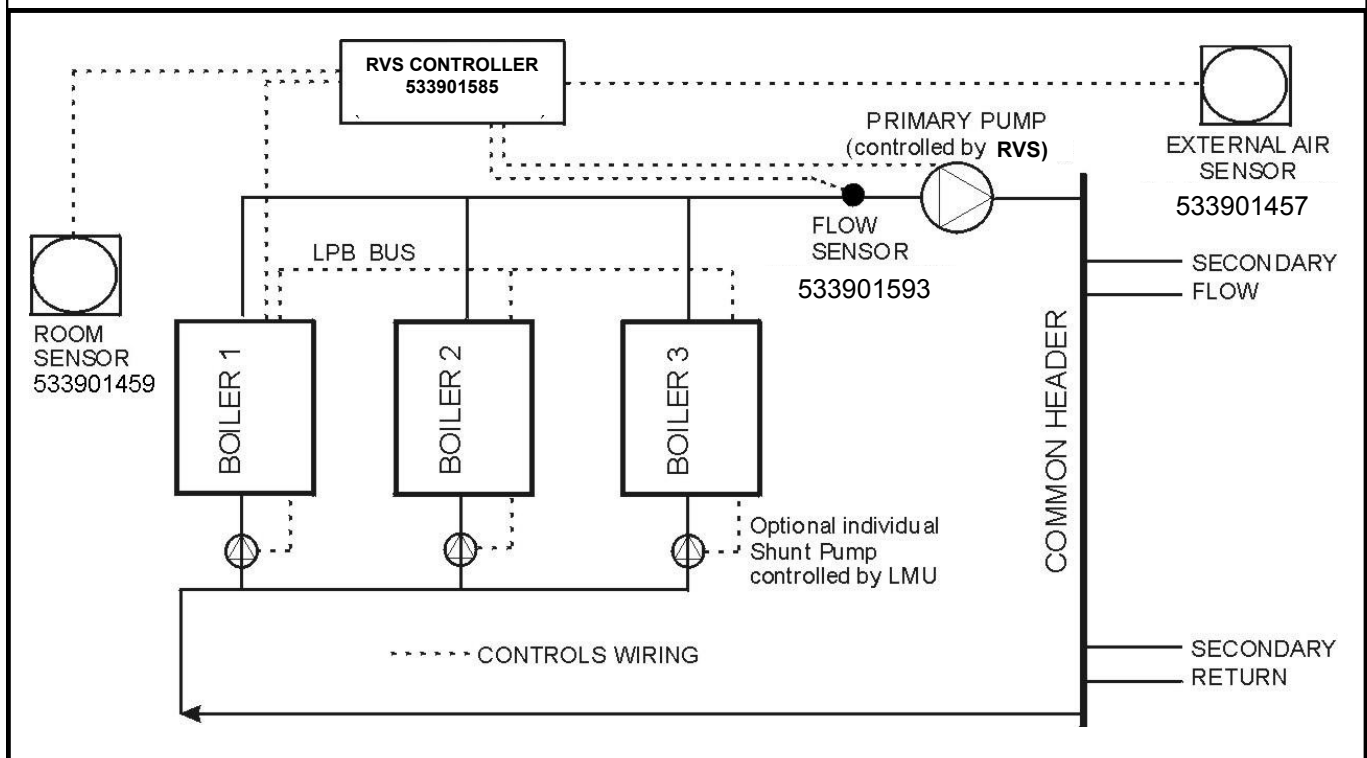

**Figure E 1.3.4 - Schematic for Multiple Boiler (Cascade), Primary Circuit System**

**USEFUL USER INFORMATION**

<b>INSTALLER</b>		<b>SITE ADDRESS</b>		

<b>BOILER TYPE</b>	<b>BOILER SIZE(S)</b>	<b>UNIT NO(S).</b>	<b>SERIAL NO(S).</b>	<b>FLUE</b>





# Notes

A large empty rectangular box with a black border, intended for notes. It has small black squares at the top-right and bottom-left corners.

# Hamworthy Heating Accredited Agents

## **Southern Ireland (Sales & Service)**

HEVAC Limited  
Naas Road, Dublin 12, Ireland  
tel: **00 353 141 91919** fax: **00 353 145 84806**  
email: **info@hevac.ie**

## **Scotland (Sales & Service)**

McDowall Modular Services  
2 Penson Road, Queenslie Industrial Estate, Glasgow, G33 4AG  
tel: **0141 336 8795** fax: **0141 336 8954**  
email:  
**MMS.McDowallModularServices@hamworthy-heating.com**

## **Northern Ireland (Sales & Service)**

HVAC Supplies Limited  
Unit A6, Dargan Court, Dargan Crescent, Belfast BT3 9JP  
tel: **028 9077 7737**  
email: **hvacsupplies@btconnect.com**

## **North East England (Service)**

Allison Heating Products  
12 Sunnyside Lane, Cleadon Village, Sunderland SR6 7XB  
tel: **0191 536 8833** fax: **0191 536 9933**  
email: **allison.heating@gmail.com**

# Hamworthy Heating Customer Service Centre

## **Sales**

tel: **01202 662552**  
email: **sales@hamworthy-heating.com**

## **Technical Enquiries**

tel: **01202 662505**  
email: **technical@hamworthy-heating.com**

## **Servicing**

tel: **01202 662555**  
email: **service@hamworthy-heating.com**

## **Spares**

tel: **01202 662525**  
email: **spares@hamworthy-heating.com**

British engineering excellence from Hamworthy Heating;  
the commercial heating and hot water specialists.



## **Customer Service Centre**

Hamworthy Heating Limited,  
Wessex House,  
New Fields Business Park,  
Stinsford Road,  
Poole,  
Dorset,  
BH17 0NF

Telephone: **01202 662500**  
Fax: **01202 662522**  
Email: **service@hamworthy-heating.com**  
Website: **www.hamworthy-heating.com**