





Accumulo (acqua calda/fredda) - Tank (hot/cold water) - Speicher (warm/kaltes Wasser) - Ballon tampon (eau chaude/froide) - Depósitos (agua caliente/fría)





Garanzia - Guarantee - Garantie
Garantie - Garantía

5 anni - 5 years - 5 Jahre
5 ans - 5 años







ITALIANO - Avvertenze per il corretto funzionamento

-  Installare una valvola di sicurezza adeguata, secondo l'etichetta e il tipo di applicazione
-  Si raccomanda il controllo periodico del funzionamento delle valvole di sicurezza (ogni mese)
-  Utilizzo esclusivamente secondo le prescrizioni indicate sulla l'etichetta del prodotto
-  Qualità di acqua di riscaldamento secondo le linee guida VDI 2035 e EN 14868
-  Evitare installazioni miste ed eseguire il collegamento del serbatoio in modo che non si creino reazioni elettrochimiche. Collegamento equipotenziale del sistema deve essere effettuato secondo la DIN 50927





ENGLISH - Warnings for correct operation

-  Install a suitable, according label and application, safety valve
-  Operation of safety valves must be checked periodically (every month)
-  The tanks are intended for use only under the conditions specified on the specification label
-  The quality of the heating (system) water has to comply with the provisions of VDI 2035 an EN 14868
-  When selecting and arranging the materials used for installing the tank, use caution and consider possible electrochemical reactions (mixed installation!). The pipe system and the tank have to be properly connected to the equipotential bonding rail according to DIN 50927





DEUTSCH - Hinweise für den korrekten Betrieb

-  Im Kaltwasserzulauf ist ein laut Typenschild und Anwendung entsprechendes Sicherheitsventil zu installieren
-  Das Trinkwasser-Sicherheitsventil soll monatlich auf Funktion geprüft werden. Eine jährliche Überprüfung durch Fachkundige wird empfohlen
-  Installation eines Feinfilters in der Kaltwasserleitung
-  Die Speicher sind ausschließlich gemäß den am Typenschild genannten Bedingungen einsetzbar
-  Das Heizungswasser muss die Vorschriften der VDI 2035 und EN 14868 entsprechen
-  Mischinstallationen vermeiden und Speicheranschluss nach der Regel der Technik ausführen, so dass keine elektrochemische Reaktionen auftreten. Der Potentialausgleich der Rohrleitungen hat gemäß DIN 50927 zu erfolgen

FRANÇAIS - Instructions de montage et mode d'emploi.

-  Installé une soupape de sécurité adéquate, selon l'étiquette et le type d'application
-  Contrôler mensuellement le fonctionnement des soupapes de sécurité
-  Les chauffe-eau doivent être exclusivement utilisés conformément aux conditions indiquées sur la plaque signalétique.
-  L'eau de chauffage doit être conforme avec les prescriptions de VDI 2035 et EN 14868
-  Évitez les installations mixtes et effectuer le raccordement de ballon, de sorte que ne se produisent pas des réactions électrochimiques. L'égalisation de potentiel de la tuyauterie doit être conforme à DIN 50927

ESPAÑOL - Advertencias para el funcionamiento correcto

-  Instalar una válvula de seguridad, de acuerdo con la etiqueta y el tipo de aplicación
-  Se recomienda el control periódico de la operación de las válvula de seguridad (mensual)
-  Use sólo de acuerdo con las instrucciones dadas en la etiqueta del producto
-  Calidad del agua de calefacción de acuerdo con la directrices VDI 2035 y EN 14868
-  Evitar instalaciones mixtas y llevar a cabo la conexión del depósito a fin de no crear reacciones electroquímicas. el sistema de compensación de potencial debe hacerse de acuerdo con la norma DIN 50927

Dati tecnici - Technical data - Technische daten

Données techniques - Datos técnicos

 I dati tecnici sono riportati nell'etichetta applicata al prodotto

 The technical data are shown on the label applied to the product

 Die technischen Daten sind dem Typenschild zu entnehmen

 Les données techniques sont indiquées sur l'étiquette apposée sur le produit

 Los datos técnicos se muestran en la etiqueta adherida al producto

 Modello - Model - Modell
Modèle - Modelo

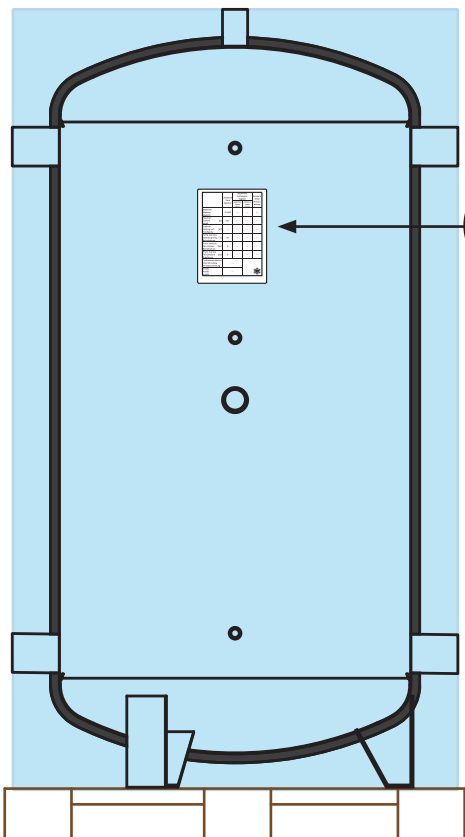

	Serbatoio Tank Speicher	Serpentine Exchangers Register		Sanitario DHW Brauchwasser
		Superiore Upper Oben	Inferiore Lower Unten	
Materiale Material Material	S235JR	---	---	---
Capacità Content Inhalt	[Lt] 732	---	---	---
Scambio Heating surf. [m²] Heizfläche	---	---	---	---
Temp. esercizio Operating temp. [°C] Betriebstemp.	95	---	---	---
Press. esercizio Op. pressure [bar] Betriebsdruck	6	---	---	---
Press. di prova Test pressure [bar] Prüfdruck	9	---	---	---
Trattamento interno Internal coating Innenbeschichtung	---			
Anodo Anode Anode	---			

Attacchi idraulici - Connections - Hydraulische Anbindung Anschluss
Raccordements - Conexiones

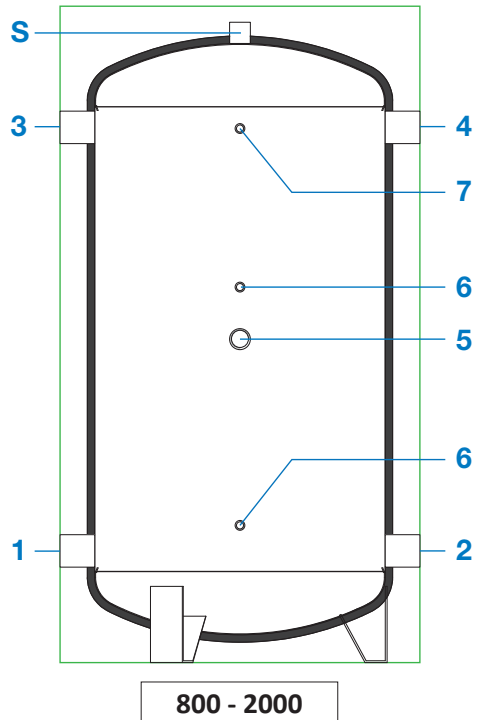
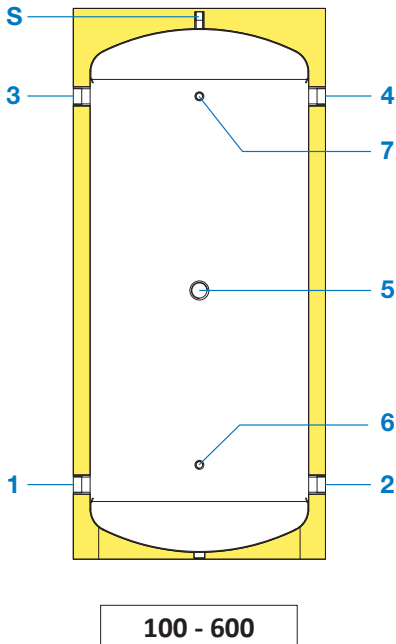
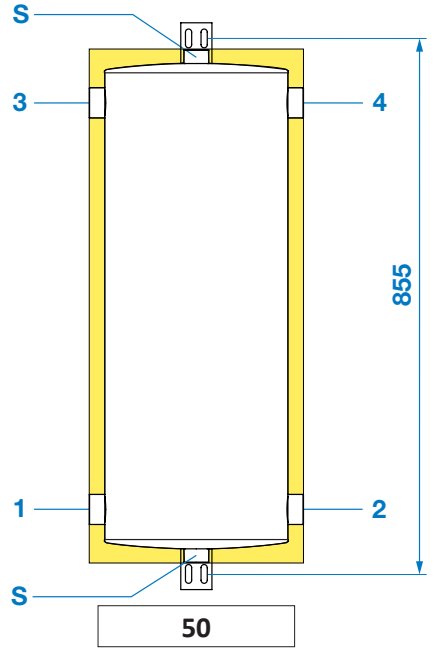
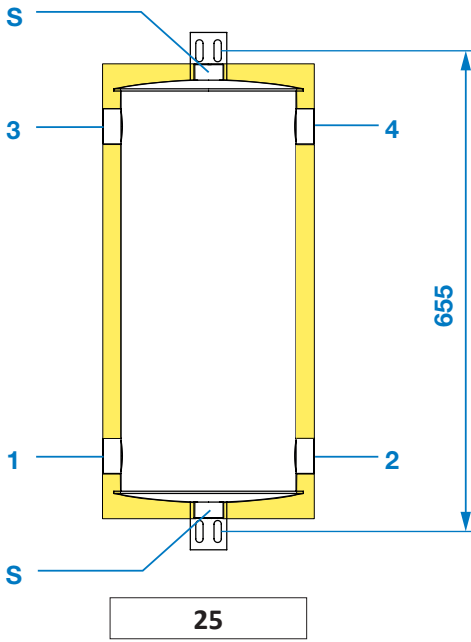

Legenda - Legend - Legende Légende - Leyenda		25 - 50	100 - 600	800 - 2000
1	Conessioni del sistema System connections Systemanschlüsse Raccordement du système Conexiones del sistema	1" ¼	1" ½	2"
2	Conessioni del sistema System connections Systemanschlüsse Raccordement du système Conexiones del sistema	1" ¼	1" ½	2"
3	Conessioni del sistema System connections Systemanschlüsse Raccordement du système Conexiones del sistema	1" ¼	1" ½	2"
4	Conessioni del sistema System connections Systemanschlüsse Raccordement du système Conexiones del sistema	1" ¼	1" ½	2"
5	Resistenza elettrica Electrical heating resistance Elektroheizstab Résistance électrique Resistencia eléctrica	-	1" ½	1" ½
6	Sonda Sensor Fühler Sonde Sonda	-	½"	½"
7	Termometro Thermometer Thermometer Thermomètre Termómetro	-	½"	½"
S	Sfiato o valvola di sicurezza Vent or safety valve Ablass oder Sicherheitsventil Aération ou soupape de sécurité Purgador o válvula de seguridad	1"	½"	1" ½

