

# **RVA47.320 CASCADE CONTROLLER**

**Including RVA46.531 Optional Zone  
Controllers for  
Additional Heating Circuits**

**For Modular Boiler Installations**

**Installation, Commissioning  
and Operating Instructions**



**NOTE: THESE INSTRUCTIONS SHOULD BE READ AND UNDERSTOOD BEFORE  
ATTEMPTING TO INSTALL, COMMISSION OR OPERATE THIS UNIT**

**PUBLICATION NO. 500001131  
ISSUE 'B'  
June 2007**

# CONTENTS

	PAGE
<b>1.0 General Overview .....</b>	<b>3</b>
1.1 Summary: RVA47.320 Cascade controller and features	
1.2 Summary: RVA46.351 Zone controller and features	
1.3 Product range	
1.4 Product liability	
<b>2.0 Handling and Installation.....</b>	<b>5</b>
2.1 Handling and installation RVA47.320 and RVA46.351 controllers	
2.2 Electrical installation RVA47.320 cascade controller	
2.3 Electrical installation RVA46.351 zone controller	
2.4 Fitting of OCI420 LPB communication relay to boiler modules	
2.5 LPB communication wiring	
<b>3.0 Commissioning.....</b>	<b>9</b>
3.1 Commissioning RVA47.320 cascade controller	
3.2 Parameter settings for end user: RVA47.320 Cascade controller	
3.3 Parameter settings for heating engineer: RVA47.320 Cascade controller	
<b>4.0 Operation.....</b>	<b>15</b>
4.1 Operation: RVA47.320 Cascade controller	
4.2 Operational fault finding: RVA47.320 Cascade controller	
4.3 Manual over-ride: RVA47.320 Cascade controller	
4.4 Addressing plant within a cascade installation	
<b>5.0 BMS 0 – 10V Enabled cascade control.....</b>	<b>19</b>
<b>6.0 Externally (time clock) enabled cascade control.....</b>	<b>21</b>
<b>7.0 RVA47.320 Cascade control using integral time clock.....</b>	<b>24</b>
<b>8.0 Cascade control systems with additional RVA46.351 zone controllers.....</b>	<b>28</b>
<b>Appendix A: Wiring for primary pump when using cascade control.....</b>	<b>34</b>
<b>Appendix B: Sensors.....</b>	<b>35</b>
B1.1 External air sensor	
B1.2 Room temperature sensors	
<b>Appendix C: Technical data .....</b>	<b>37</b>
C1.1 Technical Data RVA47.320 cascade controller	
C1.2 Technical data RVA46.351 zone controller	
<b>Appendix D: Commissioning RVA46.351 zone controller.....</b>	<b>39</b>
Parameter settings for end user: RVA46.351 Zone controller	
Parameter setting for heating engineer: RVA46.351 Zone controller	
Operation: RVA46.351 Zone controller	
Operational fault finding: RVA46.351 Zone controller	
<b>Appendix E: Operating QAA70 Programmable room sensor.....</b>	<b>46</b>

## **1.0 General Overview:**

### **1.1 RVA47 Cascade Controller Brief Description**

Controls up to 12 boilers using Siemens LMU controls. May be independently enabled by a 0-10v signal from a BMS or start/stop signal from a time clock. It also has a built in clock & uses an LPB Bus to communicate with the boilers. Each boiler control requires an extra module to communicate with the cascade controller. Operating from a BMS temperature signal or with the dedicated flow temperature sensor, cascade systems can be designed to operate up to 90°C. Dependant on application the control can offer additional features as detailed below.

- Remote operation via digital room thermostat
- Quick setback & boost heating
- Automatic 24-hour heating limit
- Automatic summer / winter changeover
- Consideration of the building's thermal dynamics
- Auto adjustment of heating curve to building type & demand
- Overload detection (shifting priority)
- Selectable boiler sequence and boiler strategy
- Weather-compensated heating circuit control
- Cascade flow temp control depending on the heat demand
- Cascade flow temp control depending on the temp demand
- Adjustable max limitation of temp signals delivered to the boiler
- Performance-related switching on/off of boilers
- Supervision of operating conditions at the low loss header
- Protection against boiler over temperatures (pump overrun)
- Adjustable min & max limitation of boiler temperature.
- Frost protection for the building, the plant and the boiler
- Pump protection through periodic pump kick
- Over temperature protection for the pump heating circuit
- 7 day or 24 hour program for the heating circuit & d.h.w. heating
- Optimised start and stop.
- Automatic button for efficient operation throughout the year
- Manual operation at the touch of a button
- Output and input tests to aid commissioning & functional checks
- Straightforward selection of operating mode via buttons
- Change of operating mode via remote switch.
- Heat generation lock or min demand for heat with remote switch
- Service connection facility for local settings & data logging
- Communication via the Local Process Bus (LPB)
- Interface with other controllers via Start/stop or 0-10V signal
- Input for cascade flow temperature sensor
- Integrity of system architecture with all RVA... controllers
- Optional remote supervision
- Error messages
- Logging the individual LMU operating hours
- Logging the number of device operating hours

### **1.2 RVA46 Zone Controller**

For use with secondary heating circuits with constant or variable temperature requirements. Integrates with the RVA47. It has a built in time clock to provide independent control for the respective heating circuit to which it is connected. Each controller can control a zone pump and a 3 port mixing valve if required. Using a zone air temperature sensor and water temperature sensor the controller can be independently programmed for compensated flow temperature, optimised start and frost protection. The zone and cascade controllers communicate via an LPB. Each zone communicates the required water temperature to the cascade controller which sets the cascade output temperature. If multiple controllers are used the cascade will set the temperature to the highest requirement. Zones requiring a lower temperature will either stop the zone pump, or modulate the mixing valve (if fitted) to prevent over heating within the zone. For zones using compensated flow temperatures the air temperature is derived from a common external air sensor connected to the RVA47 cascade controller via the LPB..

Features are dependant on the system on which they are used. Full details are provided in later chapters.

- Weather-compensated flow temperature control
- One mixing or one pump heating circuit
- Quick setback and boost heating
- Automatic 24-hour heating limit
- Automatic summer / winter changeover
- Remote operation via digital room unit
- The building's thermal dynamics are taken into consideration
- Auto adjustment of heating curve to building type & demand.
- Adjustable flow temperature boost with mixing heating circuit
- Floor curing function <sup>1)</sup>
- Adjustable max/min limitation of flow temperature
- Frost protection for the building, the heating circuit & plant
- Pump protection through periodic control (pump kick)
- 7 day or 24 hour heating program for the heating and d.h.w.
- Optimised start and stop
- Temperature adjustment with the setpoint knob
- Automatic button for efficient operation throughout the year
- Manual operation, selection of operating mode via buttons
- Output & input tests to assist commissioning and a functional test
- Service connection facility for parameter settings & data logging
- Communicating via local Process Buss (LPB)
- Communicating via point-to-point interface (PPS)
- Integrity of system architecture with all RVA... controllers <sup>1)</sup>
- Can be extended to include up to 40 heating circuits
- Optional remote supervision
- Fault status signals and indications (locally, LPB and PPS) <sup>1)</sup>
- Other controllers can deliver their heat demand signal via VFCs
- Analysis with service tool
- Display of plant diagram number

### 1.3 Range of Products

The following units and accessories are designed for use with the Hamworthy Range of boilers using Seimens LMU controls

HHL Reference	Description
563605296	RVA47.320 Cascade Control kit
563605297	RVA46.531 Heating circuit zone control kit
563605416	RVA46.531 Heating circuit zone control Module
563605417	RVA47.320 Cascade Control Module
563901438	OCI420 LPB Communication clip relay for LMU controller
533901459	QAA10 Digital room temperature sensor
533901475	QAA70 Digital, multifunctional room programmable room thermostat
533901474	QAA50 Digital room temperature sensor adjustable
533901458	QAC34 Outside sensor NTC
533901460	QAZ21 Immersion sensor LG-Ni 1000 c/w cable
533901462	AGP2S.02M LPB (2 poles) Violet - RVA47 plug-in terminals
533901467	AGP2S.02G Room unit (2 poles) Blue - RVA47 plug-in terminals
533901468	AGP2S.06A Sensor (6 poles) White - RVA47 plug-in terminals
533901469	AGP3S.02D Mains (2 poles) Black - RVA47 plug-in terminals
533901470	AGP3S.03B Pumps (3 poles) Brown - RVA47 plug-in terminals

**Note:** HHL can supply Control Kits and Control Modules. The Kits are designed to install the controls in existing panels they include the controls and wiring connectors, the Cascade Kit also includes a flow sensor, immersion pocket, 2 OCI LPB relays & QAC 34 outside temperature sensor. The modules are boxed versions of the kits designed as wall or frame mounted units.

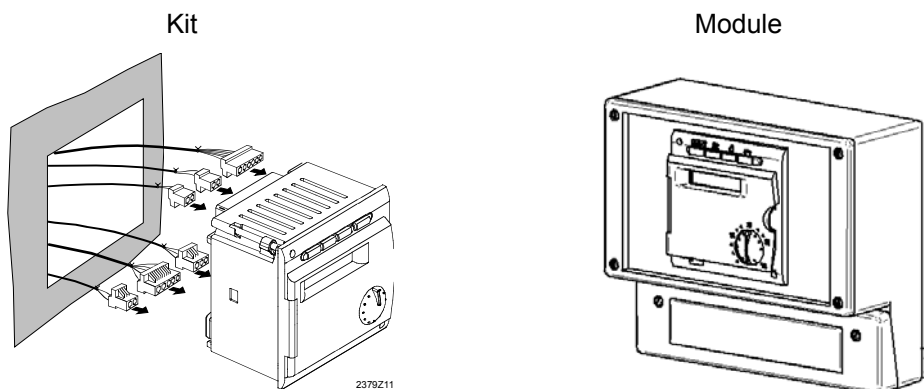

### 1.4 Product liability

- The products may only be used in building services plant and applications as described above
- All requirements specified in chapters "Handling" and "Technical data" must be satisfied
- The local regulations for installation must be complied with.

## 2.0 Handling

### 2.1.1 Installation For Cascade Controller and Zone Controller Kits

- 10mm clearance must be provided on all sides enabling the unit to dissipate heat.
- To avoid the risk of electric shock power to the controller may be supplied only after it is completely fitted.
- The controller must be mounted in compliance with the regulations of safety class 2.
- The controller must not be exposed to dripping water.
- Permissible ambient temperature: 0...50 °C

#### Mounting Procedure

- Turn off power supply
- Pull the prefabricated cables through the cut-out
- Plug polarised connectors into respective sockets.
- Ensure fixing levers are turned inward
- Ensure there is sufficient space between front panel & fixing levers
- Slide the unit into the panel cut-out without applying any force
- Secure fixing levers by tightening two screws on the controller front. Do not over-tighten.

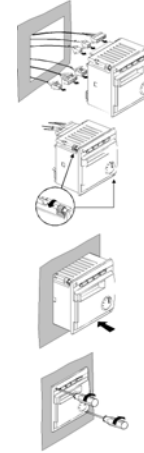

#### **CUT OUT INFORMATION:**

As mounting dimensions are 91x91mm a 92x92mm hole is recommended. The controller to be fitted in front panels having a thickness of 2mm to 10mm. It is possible to arrange several controllers in a row by using a wide cut-out. Spacing is 96mm therefore cut out for 2 should be 92x188mm. To avoid over-heating the controller inclination must be no more than 30° from vertical.

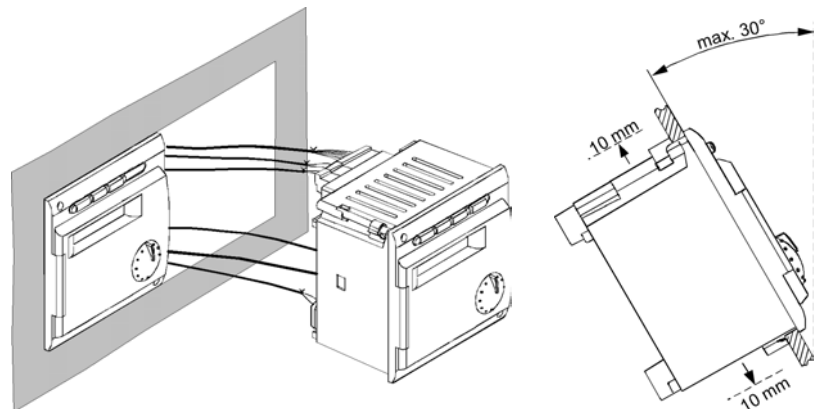

### 2.1.2 Installation For Cascade Controller and Zone Controller Modules

- To avoid the risk of electric shock power to the controller may be supplied only after it is completely fitted.
- The controller is designed along the guidelines of safety class 2 and must be mounted in accordance with these regulations.
- The controller must not be exposed to dripping water.
- Permissible ambient temperature: 0...50 °C

The modules can be mounted using the features shown on the right

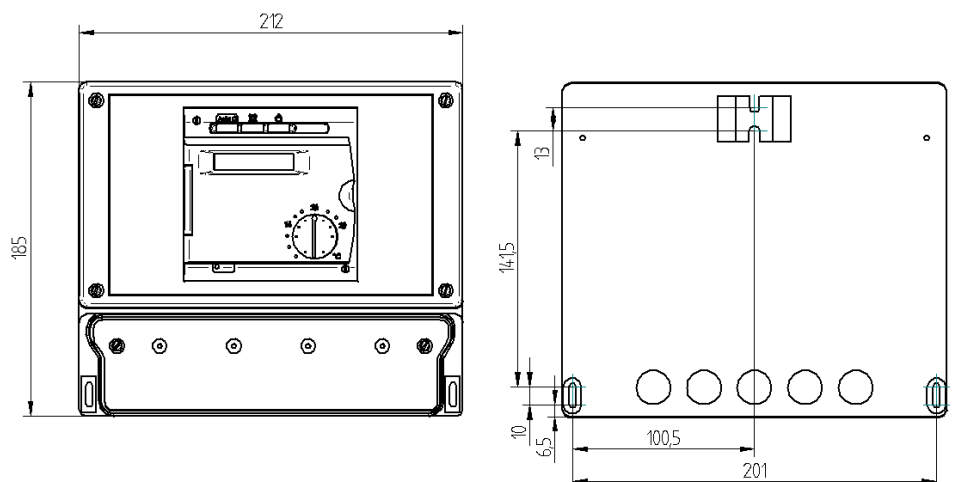

## 2.2 Electrical Installation of Kits and Modules

- The connections for mains and low voltage are separated
- Wiring must comply with requirements of safety class II.
- Sensor and mains cables must not run in the same duct

### 2.2.1 RVA47 Cascade Controller Kit

Terminal Number	Description	Connector
H1	Input H1 (Remote Cable)	AGP2S.06A (White)
B70/B4	Cascade return temp sensor B70 or buffer storage tank temp sensor B4	
B3	Dhw temp sensor or thermostat	
M	Ground sensors	
B10	Cascade flow temp sensor (common flow temp sensor)	
B9	Outside sensor	
MD	Ground PPS (room unit, BMU)	APG2S.02G (blue)
A6	PPS (room unit, BMU)	
MB	Ground bus (LPB)	AGP2S.02M (violet)
DB	Data Bus (LPB)	
Q3	Dhw charging Pump	AGP3S.03B (brown)
Q1	Heating circuit or system pump	
F1	Phase Q1/Q3	
L	Live AC 230V (mains connection)	APG3S.02D (black)
N	Neutral conductor (mains connection)	

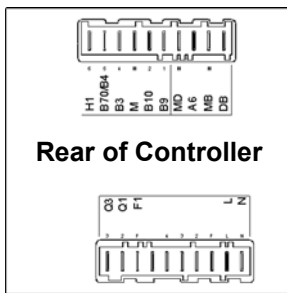

Rear of Controller

### 2.2.2 RVA46 Zone Controller Kit

Terminal Number	Description	Connector
H1	Input H1 (Remote Cable)	AGP2S.06A (White)
M	Ground Sensors	
B1	Flow Sensor Mixing Valve	
B9	Outside Sensor	
MD	Ground PPS(room unit, BMU)	AGp2S.02G (blue)
A6	PPS (room unit, BMU)	
MB	Ground bus (LPB)	AGP2S.02M (violet)
DB	Data Bus (LPB)	
Y2	Mixing valve CLOSED	AGP3S.03K (green)
Y1	Mixing valve OPEN	
F2	Phase Y1 and Y2	
Q2	Heating circuit pump	AGP3S.04K (orange)
F6	Phase Q2	
L	Mains connection (live AC 230V)	AGP3S.02D (black)
N	Mains connection (neutral conductor)	

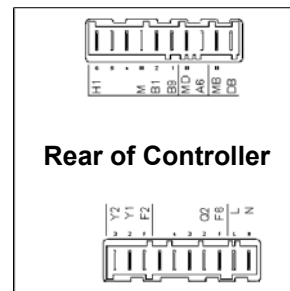

Rear of Controller

## Electrical installation of Modules

The terminal strip is accessed by removing the lower cover. Wires can be brought into the unit via holes in the base and back. The holes are designed for a range of standard conduit and glands

### 2.2.3 RVA47 Cascade Controller Kit

Terminal Identification	Description
RMTE	Input H1 (Remote Cable)
T SENS	Cascade return temp sensor B70 or buffer storage tank temp sensor B4
HW TMP/STAT	Dhw temp sensor or thermostat
GND SNS	Ground sensors
CSCDE FLW	Cascade flow temp sensor (common flow temp sensor)
OTSDE SNS	Outside sensor
GRND PPS	Ground PPS (room unit, BMU)
PPS	PPS (room unit, BMU)
GRND BUS	Ground bus (LPB)
DB	Data Bus (LPB)
Dhr CHR	Dhw charging Pump
HTG	Heating circuit or system pump
PHASE Q1/Q3	Phase Q1/Q3
MAINS LIVE	Live AC 230V (mains connection)
MAINS NTRL	Neutral conductor (mains connection)

### 2.2.4 Electrical installation RVA46 Zone Module

Terminal Identification	Description
RMTE	Input H1 (Remote Cable)
GRND SENS	Ground Sensors
FLOW VLVE	Flow Sensor Mixing Valve
OTSDE SNS	Outside Sensor
GND PPS	Ground PPS(room unit, BMU)
PPS	PPS (room unit, BMU)
GND LPB	Ground bus (LPB)
DATA LPB	Data Bus (LPB)
MX VLVE CL	Mixing valve CLOSED
MX VLVE OP	Mixing valve OPEN
PHASE Y1/Y2	Phase Y1 and Y2
HTG CRC PMP	Heating circuit pump
PHASE Q1/Q3	Phase Q2
MAINS LIVE	Mains connection (live AC 230V)
MAINS NTRL	Mains connection (neutral conductor)

**2.4.1 Fitting of OCI420 LPB communication relay to boiler modules**

Each boiler module in the cascade must be fitted with a OCI420 A109 LPB clip-in relay to enable the cascade controller to communicate with each boiler in the cascade.

The Cascade controllers are supplied with 2 x OCI420 A109 clip-in relay kits. Where 3 or more boiler modules are installed additional clip-in relay kits will be required.

All boiler modules are supplied fitted with the LMU boiler controller. As shown below the OCI420 A109 relay should be mounted to the LMU to the right of the AGU2.511 A109 relay supplied as standard with every boiler module.

Clip-in relay kit part no. 563901371

Each LPB clip-in relay is supplied in a kit containing the following:

- OCI420 communication relay – HHL Part no. 533901456
- AGU2104 clip in ribbon cable – HHL Part no. 533901440
- RAST5 Twin terminal connector, brown – HHL Part no. 533926104

Once the clip-in relay is fitted the ribbon cable should be connected between the two using terminal connections X40.

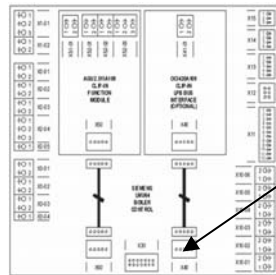

**2.5 LPB Communication wiring**

To protect of the LPB from electromagnetic disturbance, cables used for the LPB connections should be completed using shielded two core cable, preferably wire mesh shielded twisted cables. The two ends of the cable must be connected to a reference potential (building ground).

To further protect the LPB from electromagnetic disturbance these should be separated from mains cables, preferably run in separate conduits or ducts. Where mains cables and LPB cables must be run in the same duct a central divider should be used to separate the LPB cables from the mains cables.

**LPB Power Supply**

For the majority of installations the cascade controllers internal Bus power supply (parameter142 setting 1 (std)) which provides power for upto 16 devices will be sufficient. For more than 16 a central Bus power supply is required. Cables used in installations using the internal power supply must have cross-sectional area of 1.5mm<sup>2</sup>.

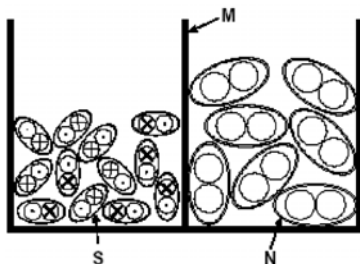

- S = Signal lines
- N = Mains Cables
- M = Metal Duct with metal walls

**LPB Cable lengths**

Using non interchangeable copper cable 1.5mm<sup>2</sup> the maximum permitted Bus cable length, including all branches, is 250 metres.

### Connecting the Bus cable

The bus cable must be connected to terminals MB(-) and DB(+) of the LPB devices. The polarity (+/-) must be observed.

The violet terminal connector must be used to connect the LPB Bus Cable to the RVA47 cascade controller. The correct polarity for the cables is printed on the rear of the controller.

The brown terminal connector must be used to connect the LPB Bus Cable to the OCI420A109 clip-in communication relay. The correct polarity for the cables is indicated in the diagram to the right (Fig 2.5).

Successive boiler modules must be connected to the LPB Bus cable in series with the first boiler module. Please see wiring diagrams in the relevant section of this manual for the type of application being used.

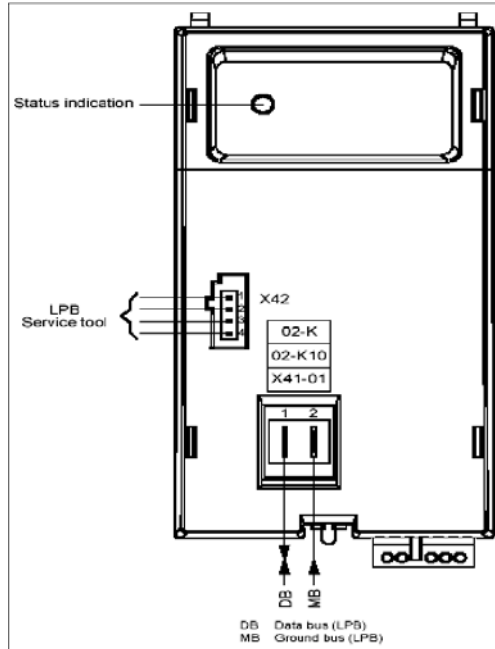

### Commissioning the Bus

- Disconnect the Bus communication and power supply to all devices.
- Unplug the Bus connector (violet LPB connector) and that of the power supply (black connector).
- Put all devices into operation, individually and autonomously by re-establishing the power supply.
- Plug the black connector into N/L again. Do not plug the LPB connector in yet.

Address the device with the setting on the lines 'device' and 'segment' address as follows;

Plant	Address	Segment
RVA47 Parameter	140	141
RVA47 Address	1	0
Parameter	605	606
LMU Blr 1	2	0
LMU Blr2	3	0
LMU Blr12	13	0

Additionally each boiler module LMU controller must also be configured for cascade control by setting parameter 552 to 80. See boiler parameter setting procedure boiler installers guides.

- After switching on the mains voltage it may take 30 seconds until the Bus power supply is switched on.
- Connect the controller to the Bus using the violet LPB connector (Check polarity).
- Check the Bus power supply each time a device is connected (violet LPB connector).

At any location along the Bus (DB+, MB-), the voltage must be a minimum of DC 9.5 Volts.

If the voltage is negative, the Bus connection has been mixed up.

If the voltage is too low, the Bus power supply is not sufficient.

If no voltage is present, there is a short circuit.

Check the Bus communication indication against the setting..



## 3.0 Commissioning

### 3.1 Setting Parameters

The controller has 173 different parameters which can be examined or set. These are separated into 2 groups, End User (1-50) and the Heating Engineer (50-173)

To access the enduser parameters press both program buttons simultaneously.

To access the heating engineer parameters press both buttons simultaneously for at least 3 seconds



Pressing the individual prog buttons will scroll up or down through the parameters.

Pressing the — or + buttons will change the setting of the displayed parameter.

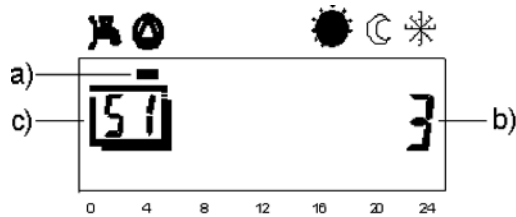

- a) Mark below symbol indicates output activated.
- b) Number indicates the parameter setting.
- c) Framed number indicates selected parameter.

The selected sensor values are updated within 5 seconds. If no sensor is present, the connecting line interrupted or contact open the display shows —. In the event of a short circuit the display shows 000.

Leave the programming mode by pressing one of the operating mode buttons



### 3.2 Commissioning RVA47 Cascade controller

- Ensure the mounting and electrical installation are in compliance with the relevant requirements.
- Set plant-specific settings.
- Reset the attenuated outside temperature by pressing the -&+ buttons for 3 seconds in parameter 19
- Access parameter 51 (Heating Engineer Group) and press the— or + buttons to cycle through and check the following settings:
  - 0– Control mode according to the operationla status
  - 1– All outputs are deactivated
  - 2– Dhw charging pump ON Q3
  - 3– Heating circuit/system pump on Q1
- Access parameter 52 (Heating Engineer Group) and press the– or + buttons to cycle through and check the following readings:
  - 0- Display of buffer temp sensor or cascade return temp (selected by parameter 97)
  - 1- Display of dhw temperature
  - 2- Display of cascade flow temperature
  - 3- Display of the actual outside temperature
  - 4- Display the temperature from the room unit
  - 5- Display of input H1 (set by parameter 170)

### 3.3 Enduser Parameter settings for the Cascade Controller

The table below shows the parameters to be set or adjusted in the controller. The procedure for setting these is shown in section 3.1

Line	Function	Range	Unit	Resolution	Works Set
<b>Setting the Clock</b>					
1	Time of Day	0... 23:59	h/min	1 min	-
2	Weekday	1... 7	Weekday	1 day	-
3	Date (day, month)	01.01... 31.12	Dd.MM	1	-
4	Year	1999... 2099	jjjj	1	-
<b>Time Switch Program for heating circuit</b>					
5	Weekday - pre-selection heating circuit 1-7 7-day block 1... 7 Individual days	1-7 / 1...7	Weekday	1 day	-
6	Switch-on time 1. 3rd period heating circuit	00:00...23:59	h/min	10 min	06:00
7	Switch-off time 1. 3rd period heating circuit	00:00...23:59	h/min	10 min	22:00
8	Switch-on time 2. 3rd period heating circuit	00:00...23:59	h/min	10 min	—:—
9	Switch-off time 2. 3rd period heating circuit	00:00...23:59	h/min	10 min	—:—
10	Switch-on time 3. 3rd period heating circuit	00:00...23:59	h/min	10 min	—:—
11	Switch-off time 3. 3rd period heating circuit	00:00...23:59	h/min	10 min	—:—
<b>D.h.w Values</b>					
13	Nominal setpoint pf the d.h.w. temperature (TBWw) TBWR Line 120 TBWmax Line 40 (OEM)	TBWR...TBWmax	°C	1	55
<b>Heating Circuit Values</b>					
14	Reduced room temperature setpoint (TRRw) TRF Line 120 TRN Setpoint knob	TRF...TRN	°C	0.5	16
15	Frost protection setpoint of the room temperature (TRFw) TRR Line 14	4...TRR	°C	0.5	10
16	Summer / winter changeover temperature	8...30	°C	0.5	17
17	Heating curve slope -:— Inactive 2.5...40 Active	-:— / 2.5...40	-	0.5	15
<b>Actual Values</b>					
18	Actual value of the room temperature (TRx)	0...50	°C	0.5	-
19	Actual value of the outside temperature (Tax) To set the attenuated outside temp. to Tax, press the +/- buttons simultaneously for 3 seconds	-50...+50	°C	0.5	-
<b>Maintenance</b>					
23	Standard time program for heating circuit and d.h.w To activate, press the + and - buttons simultaneously for 3 seconds.	0/1	-	1	0
<b>Time Switch Program for d.h.w. Heating</b>					
29	Pre-selection of weekday 1-7 7-day block 1...7 Individual days	1-7 / 1...7	Weekday	1 day	-
30	Switch-on time 1. 3rd period d.h.w.	00:00... 23:59	h/min	10 min	06:00
31	Switch-off time 1.3rd period d.h.w.	00:00... 23:59	h/min	10 min	22:00
32	Switch-on time 2. 3rd period d.h.w.	00:00... 23:59	h/min	10 min	—/—
33	Switch-off time 2. 3rd period d.h.w.	00:00... 23:59	h/min	10 min	—/—
34	Switch-on time 3. 3rd period d.h.w.	00:00... 23:59	h/min	10 min	—/—
35	Switch-off time 3. 3rd period d.h.w.	00:00... 23:59	h/min	10 min	—/—
<b>Service</b>					
50	Indication of faults	0...255 / 00.01-14.16	-	1	-

### 3.4 Heating Engineer Parameter settings for the Cascade Controller

The table below shows the parameters to be set or adjusted in the controller. The procedure for setting these is shown in section 3.1

If an LMU is connected via LPB parameters 55,58,6580,81,82,83,90,91,92,93 & 94 will be inactive and will have to be made directly on the LMU

Line	Function	Range	Unit	Resolution	Works Set
<b>Service Values</b>					
51	Output test (relay test) 0 Control mode according to the operational status 1 All outputs are deactivated 2 D.h.w. charging pump ON Q3 3 Heating circuit / system pump on Q1	0... 3	-	1	0
52	Input Test (sensor test) 0 Cascade return temperature sensor B70/B4 or buffer storage tank temperature sensor 1 D.h.w. temperature sensor B3 2 Cascade flow temperature sensor B10 3 Outside temperature sensor B9 4 Room temperature sensor (room unit) A6 5 Input H1 H1	0... 5	-	1	0
53	Display of plant type	27... 36 / 65... 67	-	1	-
54	Displaying the PPS communication — No communication 1... 12 PPS device address 0...255 Identification code	— / 1.. 12 / 0.. 255	-	1	-
<b>Actual Values</b>					
55	Actual value of boiler temperature of BMUs (TKx) 1... 4 = BMU number, 0... 140 = actual value of boiler temperature (interrogate with + / - buttons)	1... 4 / 0... 140	°C	1	-
56	Actual value of cascade flow temperature Input B10	0... 140	°C	1	-
57	Actual value of cascade return temperature Input B70	0... 140	°C	1	-
58	Actual value of buffer storage tank temperature Input B4	0... 140	°C	1	-
59	Actual value of the d.h.w. temperature (TBWx) (input B3 or value from BMU)	0... 140	°C	1	-
60	Attenuated outside temperature (Taxged)	-50.0... +50.0	°C	0.5	-
61	Composite outside temperature (TAXgem)	-50.0... +50.0	°C	0.5	-
62	Outside temperature source —, — No signal 00.01 Segment / device address	— / 00.01... 14.16	-	-	-
<b>Setpoints</b>					
65	Setpoint of the boiler temperature of BMUs (TKx) 1.4 = BMU number, 0... 140 = actual value of boiler temperature (interrogate with + / - buttons)	1... 4 / 0... 140	°C	1	-
66	Setpoint of the cascade flow temperature	0... 140	°C	1	-
69	Setpoint of the d.h.w. temperature (TBWw)	0... 140	°C	1	-
70	Nominal room temperature setpoint Nominal setpoint plus readjustment made on the room unit	0.0... 35.0	°C	0.5	-
71	Setpoint of room temperature (TRRw)	0.0... 35.0	°C	0.5	-
72	Flow temperature setpoint (TVw)	0... 140	°C	1	-
<b>Heat Generation Values</b>					
75	Display of the available cascade boilers (— = none)	— / 00.1... 16.3	-	01.1	-
76	Display lead boiler	— / 00.1... 16.3	-	01.1	-
77	Remaining number of operating hours for changeover of boiler sequence. Only if value is selected on line 130, otherwise the LCD displays —	0... 990	h	1	-

## Heating Engineer Parameters overview for the RVA47.320 Cascade Controller (continued)

Line	Function	Range	Unit	Resolution	Works Set
80	Burner hours run BMU 1	0... 65535	h	1	0
81	Burner hours run BMU 2	0... 65535	h	1	0
82	Burner hours run BMU 3	0... 65535	h	1	0
83	Burner hours run BMU 4	0... 65535	h	1	0
90	Minimum limitation of the boiler temperature (TKmin)	TKmin OEM... TKmax (max 95°C)	°C	1	8
91	Nominal output BMU 1	0... 255	kW	1	20
92	Nominal output BMU 2	0... 255	kW	1	20
93	Nominal output BMU 3	0... 255	kW	1	20
94	Nominal output BMU 4	0... 255	kW	1	20
<b>Configuration of Plant</b>					
95	Pump function output Q1 1 Heating circuit pump or no pump 2 System pump for heating circuits only 3 System pump for heating circuits and d.h.w storage tank 4 D.h.w circulating pump 5 Pump H1	1... 5	-		1
97	Use sensor input B70 / B4 1 Cascade return temperature (B70) 2 Buffer storage tank temperature sensor (B4)	1... 2	-	1	1
<b>Space Heating</b>					
100	Parallel displacement of the heating curve	-4.5... +4.5	K (°C)	0.5	0.0
101	Room influence 0 Inactive 1 Active	0 / 1	-	1	1
102	Switching differential of the room temperature (SDR) - / - Inactive 0.5... 4.0 Active	— / 0.5... 4.0	K (°C)	0.5	— / -
103	Minimum limitation of the flow temperature setpoint (TVmin) TVmax Line 104	8... TVmax	°C	1	8
104	Maximum limitation of the flow temperature setpoint (TVmax) TVmin Line 103	TVmin... 95	°C	1	80
105	Type of building construction 0 Heavy 1 Light	0 / 1	-	1	1
106	Adaptation of the heating curve 0 Inactive 1 Active	0 / 1	-	1	1
107	Maximum forward shift of optimum start control 0 No forward shift	00:00... 06:00	hh:mm	10 min	00:00
108	Maximum forward shift of optimum stop control 0 No forward shift	00:00... 06:00	hh:mm	10 min	00:00
<b>D.h.w.</b>					
120	Reduced setpoint of d.h.w. temperature (TBWw) TBWw Line 13	8... TBWw	°C	1	40
121	Release of d.h.w. heating 0 24 h/day 1 According to the heating circuit time switch program(s) with forward shift 2 According to d.h.w. time switch program (lines 29... 35)	0...2	-	1	1
122	Switching program circulating pump 0 According to heating circuit time switch program 1 According to release of d.h.w. heating	0... 1	-	1	1

## Heating Engineer Parameters overview for the RVA47.320 Cascade Controller (continued)

Line	Function	Range	Unit	Resolution	Works Set
123	Assignment of d.h.w. heating 0 For local consumer only 1 For all consumers in the same segment 2 For all consumers in the system	0... 2	-	1	2
124	D.h.w. charging 0 Once per day (forward shift 2.5 h) 1 Several times per day (forward shift 1 h)	0 / 1	-	1	1
125	Type of d.h.w. demand 0 sensor 1 Control thermostat	0 / 1	-	1	0
126	Flow temperature boost for d.h.w.	0... 30	K	1	16
127	D.h.w. priority 0 MK + PK absolute 1 MK + PK shifting 2 None (parallel) 3 MK shifting, PK absolute	0... 3	1	1	1
129	Demand for heat with reduced d.h.w. setpoint 0 No (application with buffer storage tank) 1 Yes	0 / 1	-	1	1
<b>Boiler Cascade</b>					
130	Changeover of boiler sequence in cascades — No automatic changeover (fixed boiler sequence) 10... 990 Changeover according to the selected number of hours	— / 10... 990	- / hours	10	500
131	Exclusion with auto. Changeover of boiler sequence 0 none 1 First boiler 2 Last boiler 3 First and last boiler	0... 3	-	1	0
132	Lead boiler with the fixed sequence	00.1... 16.3	-	01.1	-
133	Switch-on delay lag boilers	2... 120	min	1	5
134	Restart lock of BMUs	0... 1800	s	10	300
<b>LPB / System</b>					
140	LPB device address 0 Standalone 1...16 Device number	0... 16	-	1	1
141	LPB segment address 0 Central segment (heat generation) 1...14 Segment (heat consumers)	0... 14	-	1	0
142	LPB power supply 0 Off (central bus power supply) 1 AUTOMATIC (controller - bus power supply)	0 / 1	-	1	1
143	Displaying the LPB power supply	ON / OFF	-	-	-
144	Displaying the LPB communication	ON / OFF	-	-	-
145	Range of action of central changeover 0 In the segment 1 In the system (if segment address = 0)	0 / 1	-	1	1
146	Automatic summer / winter changeover 0 Effect on local heating circuit only 1 Central changeover of all heating circuits	0 / 1	-	1	0
147	Central standby switch 0 OFF (inactive) 1 ON (all units on standby)	0 / 1	-	1	0
148	Clock mode 0 Autonomous clock 1 System time without remote adjustment 2 System time with remote adjustment 3 System clock (master)	0... 3	-	1	3
149	Winter- / summertime changeover	01.01... 31.12	tt.MM	1	25.03
150	Summer- / wintertime changeover	0.1.01...31.12	tt.MM	1	25.10

## Heating Engineer Parameters overview for the RVA47.320 Cascade Controller (continued)

Line	Function	Range	Unit	Resolution	Works Set
<b>Input H1</b>					
170	Input H1 0 Changeover of operating mode (HC standby / d.h.w. off) 1 Changeover of operating mode (HC standby) 2 Minimum setpoint of flow temperature (setting on line 171) 3 Heat generation lock 4 Heat demand DC0... 10V	0... 4	-	1	0
171	Minimum setpoint of flow temperature contact H1 If activated at input H1 (setting 2)	8... TKmax	°C	1	70
172	Maximum value of heat demand If activated at input H1 (setting 4)	5... 130	°C	1	100
173	Operating action of the contact H1 0 N.C. contact 1 N.O.	0 / 1	-	1	1

## 4.0 Operation

### 4.1 Operation: RVA47.320 Cascade controller

A quick reference booklet can be found behind the unit's front cover.

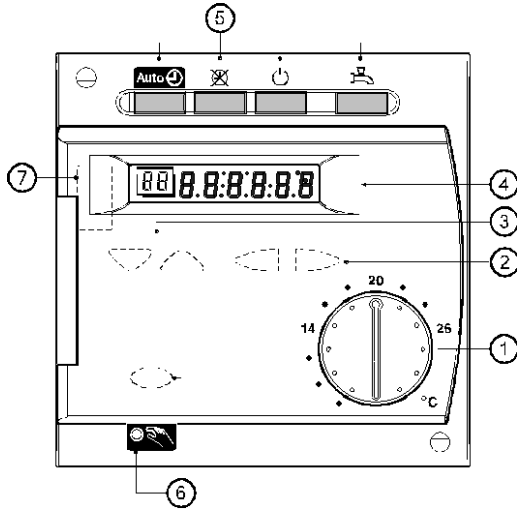

Item	Operating Element	Function
1	Room temperature setpoint knob	Adjustment of room temperature setpoint
2	Setting buttons	Parameter settings
3	Line selection buttons	Selection of parameters / switching of lines
4	Display	Readout of actual values and settings
5	Operating mode buttons	<b>Auto</b> Automatic operation Continuous operation Standby D.h.w heating on/off
6	Function button with LED for manual operation	Manual operation on / off
7	Connection facility for PC tool	Diagnostics and service

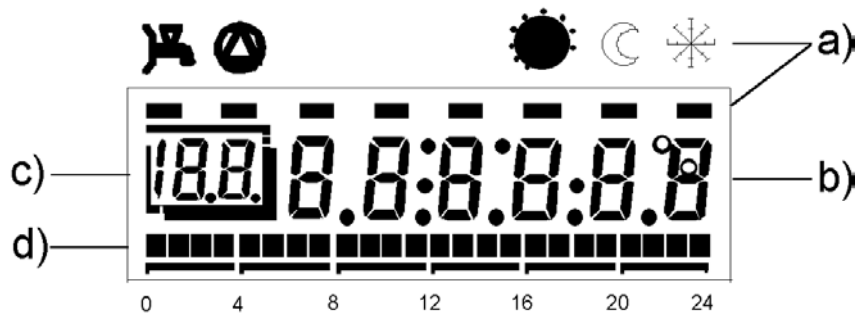

- a) Symbols for indicating the operational status with the black bars (level pointers). When the ECO function is active, the current level pointer flashes.
- b) Display during normal control mode or when making settings.
- c) Parameter number when making settings
- d) Time bar for normal control mode or when making settings.

#### Normal Operation Screen

During normal operation the screen display of the cascade controller will be similar to that shown on the right.

The display shows the actual cascade flow temperature as measured by cascade flow temperature sensor situated in the common flow header pipework.

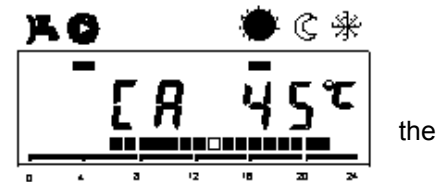

CA Indicates that the RVA47 Cascade Controller is working in cascade operation.

The procedure for setting the parameters can be found in section 3.1

## 4.2 Operational fault finding: RVA47 Cascade controller

### No display on the controller:

- Is the heating plant's main switch turned on?
- Are the fuses in order?
- Check the wiring

### Controller displays the wrong time of day:

- Set the correct time of day on the controller (parameter 1).
- Set the correct time of day on the clock master (if present).

### One of the BMUs does not switch on

- Does the LMU really have to operate? (Check cascade lead strategy, delayed switching on?)
- Press LMU's lockout reset button.
- Check the electromechanical control thermostat (TR) and the manual reset safety limit thermostat (STB)
- Check wiring and fuse of the LMU.
- Check communication link to the LMU (operating line 54)
- Check wiring of the cascade temperature sensors (sensor test, parameter 52).

### One of the pumps does not run

- Is the right type of plant displayed? (parameter 53)
- Is the pump correctly defined (Parameter 95)
- Check wiring & fuse of pump (rly test, Parameter 51)
- Check wiring of sensors (sensor test, Parameter 52)

### D.h.w. is not being heated:

- Has the button for d.h.w. heating been pressed?
- Check setpoint of the d.h.w. temperature
- Check if d.h.w. heating is released
- Check wiring & fuse of charging pump (relay test, Parameter 51)
- Check wiring of d.h.w. temperature sensor (sensor test, parameter 52)
- Check setting of electromechanical control thermostat (TR) on the boiler. It must be above the TKmax setting

### The room temperature does not match the required temperature level:

- Does the room temperature setpoint match the required temperature level?
- Is the required operating mode indicated?
- Are weekday, time of day and the displayed heating program correct? (Parameters 1...11)
- Is heating curve slope correct (Parameter 17)?
- Check wiring of outside sensor (Parameter 52)
- Has the "Setting knob for the nominal room temperature setpoint" with the "Parallel displacement of the heating curve" (parameter 100) been calibrated based on the effective room temperature?

### Error message; display shows 'ER'

In normal operation the controller display indicates, 'Er', when a fault has occurred within the controller or within the system.



## 4.3 Error Codes

The error message code is stored at parameter line, '50', in the respective controller (see section 3.1 for accessing parameters)

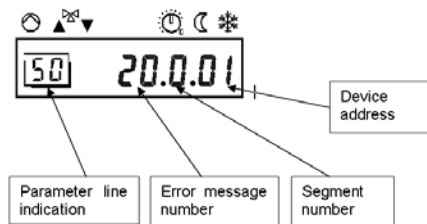

**Error message number:** a table of numbers and descriptions of the associated errors can be found below.

**Segment number:** segment address of the faulty device. There may be up to 14 operating segments in a system. Segments 10-14 are indicated by letter A, B, C, D, E.

**Device address** indicates which device within the operating segment is at fault.

**Note:** Segment number and address number will not be shown when the fault is associated with the device being interrogated only when the fault is associated with an alternative device within the system.

The controller can store and indicate a maximum of 2 error messages. By using the navigation buttons  it is possible to scroll between the error message numbers should more than 1 fault be present. The fault will remain indicated until the cause of the fault has been rectified



Error message N°	Description of fault
Blank	No Fault
10	No communication with outside air temp sensor: No sensor fitted, faulty sensor or wiring.
26	No communication with cascade flow temperature sensor: No sensor fitted, faulty sensor or wiring.
46	No communication with cascade return temperature sensor: No sensor fitted, faulty sensor or wiring. Note most applications do not require this sensor.
50	No communication with d.h.w. temperature sensor: No sensor fitted, faulty sensor or wiring. Note most applications do not require this sensor.
58	Short circuit through d.h.w. thermostat: Faulty thermostat or wiring.
61	Fault with room temp sensor: Faulty sensor or wiring.
70	No communication with buffer storage tank temperature sensor: No sensor fitted, faulty sensor or wiring. Note most applications do not require this sensor.
81	Fault with 'BUS', communication between devices: Possible short, incorrect polarity or wiring fault.
82	Address collision: Two or more devices with the same address.
86	Short circuit with 'PPS', system: Wiring fault to room sensors.
100	2 or more master clocks set within system.
145	Incorrect device connected to 'PPS', system. Incorrect device connected to room sensor terminals.
146	Inadmissible plant configuration.
147	No boiler connected. Fault with wiring to boiler on 'BUS', system or BUS not connected. Possible parameter setting error within boiler modules. Check boiler parameter H618 = 0 Check boiler parameter H615 = 0 Check boiler parameter H552 = 80 Check boiler parameter H606 = 0 Check boiler parameter H650 = As required for addressing Check RVA47 parameter P140 = As required for addressing Check RVA47 parameter P141 = 0 Check RVA47 parameter P142 = 1 Check LPB wiring and power supply. See section 2.5
150	General boiler fault. See error codes in boiler manual.

#### 4.4 Manual override

It is possible to override automatic operation, by using the manual override button.  By pressing this button during the normal operation of the cascade controller, all external or internal enabling signal will be disregarded. Once pressed the following operations commence;

1. All boiler modules are released from the cascade to operate at pre-defined setpoint 80°C.
2. Heating circuit pump Q1, where connected, is enabled.
3. D.h.w. Pump Q3, where connected, is enabled.

**The boiler modules will continue to operate at 80°C until the manual override button is pressed again** when the cascade controller resumes automatic operation, either using the external enable signal, or the internal time clock, dependent upon how the control has been configured.

#### 4.5 Addressing Plant within a cascade Installation

All items of plant within the cascade must be assigned an address within the bus for communication and identification purposes. The address is comprised of a segment address and a device address.

##### Segment Address

This is used to group devices having a common purpose together. eg all heat generating plant in one segment.

##### Device Address

This is used to identify the address of devices within the same segment. The addresses must be assigned in the direction of heat flow, i.e. starting with heat generation, and then heat distribution.

Plant	Address	Segment
RVA47 Parameter	140	141
RVA47 Address	1	0
Parameter	605	606
LMU Blr 1	2	0
LMU Blr 2	3	0
LMU Blr 3	4	0

**Segment 0;** This segment is reserved for heat generation with a boiler cascade controller, which can supply heat to subsequent segments where used.

**Address 1;** This address is reserved within the boiler cascade for the RVA47 control. Addresses 2 - 16 should first be assigned to the boilers and then to any heat distribution control.

Additionally each boiler module LMU controller must also be configured for cascade control by setting parameter 552 to 80.

#### **4.5 Procedure for accessing boiler parameters**

The procedure for changing the parameters in the boiler controls can be found in the installers guide for the boiler.

Warning changing parameters in the Heating Engineers Level could stop the boiler working correctly. Be careful only to change the parameter values detailed in this manual.

## 5.0 BMS 0 - 10V Enabled Cascade Control

### Description of system type

The RVA47 controls up to 12 boilers when controlled by BMS system providing a 0-10v signal. Temperature regulation for the primary circuit is in accordance with the BMS heat demand signal at the analog input H1. All other control functions, e.g. primary pump control, safety interlocks etc, are to be catered for by the BMS.

### External control signal

Boiler cascade is initiated when the enable signal is received. This should be in the form of a 0-10v analog signal across input H1 of the controller (H1 live signal, M ground signal). Cascade control will remain active until the external input is disabled. The operating range for the 0-10v input signal can be set within 5-90°C limits. 90°C is the maximum because the LMU boiler control will override requests for higher operating temperatures.

### Safety interlocks

Function of the BMS. When activated BMS should reduce the signal to 0v setting the RVA47 to standby.

### Frost protection

Function of the BMS. When required BMS should activate and verify pump operation before signalling the RVA47 into operation at the required heat demand. BMS frost protection set-point should be > 5°C to ensure circulation.

### Primary pump

Control must be derived from the BMS. Should be started and verified prior to signalling the RVA47. It is good practice to equip pump controls with hand/off/auto switches for maintenance and commissioning purposes.

### Secondary circuits

All secondary circuit functions in this type of system are the responsibility of the BMS system.

### Hardware required

1. Boiler cascade control kit. Flow sensor & pocket provided with kit are not required for this type of installation.
2. OCI420 Communication interface relay kits for fitting to boilers. 1 Additional relay will be required for each boiler in excess of the standard 2 relays provided with the RVA47 boiler cascade control kit.
3. QAC31 External Air Sensor

### Features available with this application type

- Boiler cascade control & Lead Boiler rotation
- Primary circuit temperature control according to 0 – 10 volt analog input
- Display of Primary circuit temperature
- Display of fault codes, 2 most recent faults only (see section 4.2)

Parameter	Function	Factory Set	Req'd Set	Notes
17	Heating Curve	15	-:—	Disables weather compensation
130	Lead boiler rotation	500 hrs	As req'd	Changes lead boiler after set period of operation
133	Boiler switch-on delay	5 min	As req'd	Time delay between boiler modules starting
134	Boiler re-start delay anti-cycle	300 sec	As req'd	Time delay for restart after switch off
170	Control input H1	0	4	Input for 0-10v heat demand from BMS
172	Max value for heat demand	100	Max operating temp	Sets temp when input signal at H1=10v See notes

### Required Parameter Changes

- T Maximum value of heat demand  
 S Minimum limitation of heat demand = 5°C

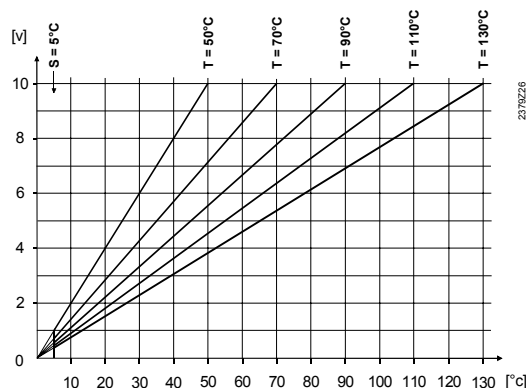

External controls can transmit a demand for heat in the form of a analog signal of 0 – 10V DC. The RVA47.320 converts this signal to a temperature setting for the cascade set-point. The set-point for 10V can be set using parameter 172 in the range 0 - 90°C.

\*\* The maximum setting of 90°C is a result of the application with the boiler LMU control which has a maximum setting of 90°C and will override any request for higher operating temperatures.

Plant	Address	Segment
RVA47 Parameter	140	141
RVA47 Address	1	0
Parameter	605	606
LMU Blr 1	2	0
LMU Blr 2	3	0
LMU Blr 3	4	0

See section 3.1 for boiler parameter setting procedure.

Additionally each boiler LMU controller must also be configured for cascade by setting parameter 552 to 80.

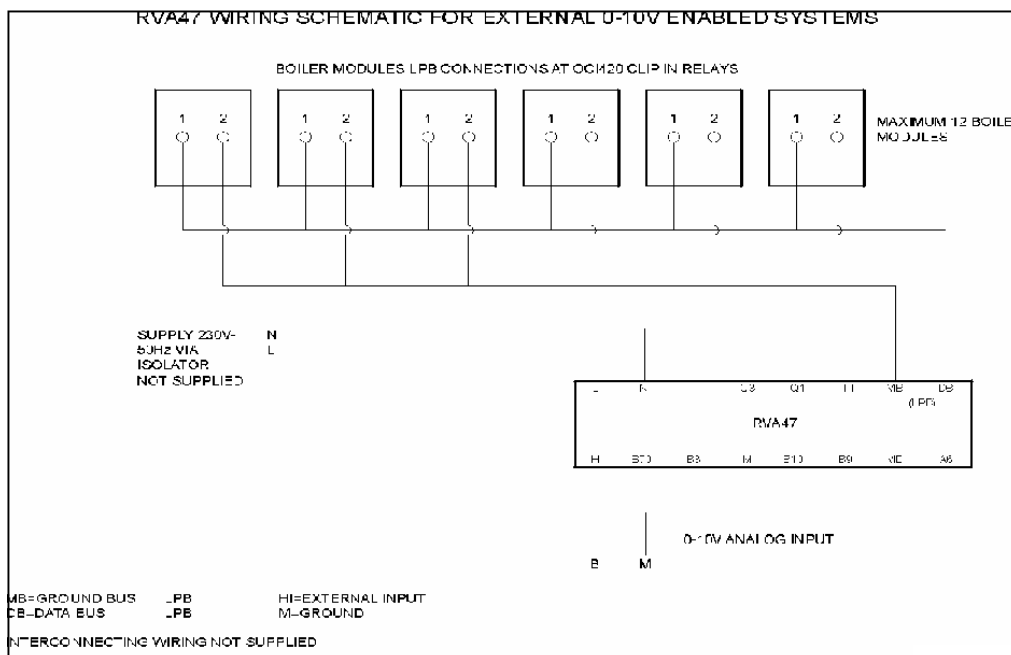
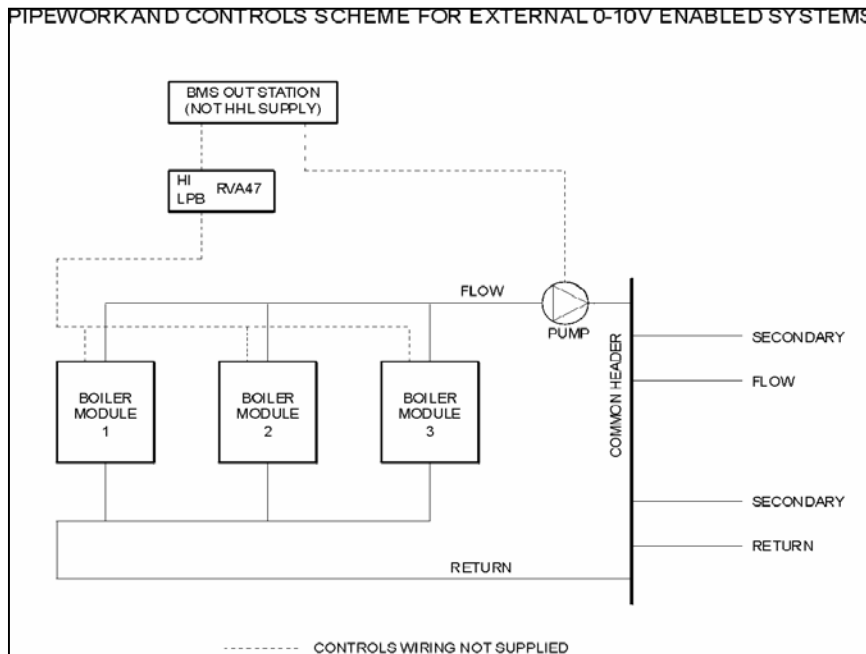

## **6.0 Externally (time clock) enabled cascade control**

### **Description of system type**

The RVA47 controls up to 12 boilers when controlled by a BMS system providing a volt free enable signal. The controller regulates the primary circuit temperature according to the program set during commissioning.

The operating range for the cascade can be set within the 5-90°C band limits. 90°C is the maximum because the boiler control will override requests for higher operating temperatures.

### **External control signal**

Boiler cascade is initiated when an enable signal is received. This signal should be in the form of a volt free contact across input H1 of the controller ( a volt free switched circuit must be fitted between H1 and M of the white 6 terminal connector on the back of the cascade controller). Cascade control remains active until the external input is disabled or temperature controls associated with the cascade controller are satisfied.

### **Primary pump**

Control signal for the primary pump is derived from the boilers controls which activate their pump output signal when a heat demand is received from the boiler cascade controller. See wiring diagram and instructions in Appendix A at the rear of this manual.

It is good practice to equip pump controls with hand/off/auto switches for maintenance and commissioning purposes. See primary pump wiring schematic in Appendix A.

### **Safety interlocks**

These circuits must be connected individually and directly to the boilers LMU controllers. In situations where the interlock circuit is triggered, by opening the contact on the LMU, the boiler will immediately shut down. During safety interlock triggered shutdowns functions that enable boilers are disabled, excluding frost protection.

### **Frost protection**

This is a function of the RVA47 cascade controller and the boilers LMU control. When frost protection as either a temperature requirement for the primary circuit or as an internal temperature requirement for the boiler is required, either the RVA47 or the boiler LMU control will start the primary pump and initiate boiler operation.

### **Secondary Circuits.**

All secondary circuit functions are the responsibility of external controls and independent of the boiler cascade.

### **Hardware Required**

1. Boiler cascade control kit. Flow sensor & pocket provided with kit must be used with this type of installation.
2. OCI420 Communication interface relay. Additional relay kit will be required for each boiler in excess of the standard 2 relays provided with the RVA47 boiler cascade control kit.
3. QAC34 External air sensor.

### **Features available with this system type**

- Boiler cascade control & lead boiler rotation
- Primary circuit temperature control according to internal program.
- Display of Primary circuit temperature.
- Display of fault codes, 2 most recent faults only (see section 4.2)
- Frost protection for boilers and primary circuit

### **Flow sensor**

The QAZ21 supplied with the cascade control kit must be fitted using the pocket provided. It should be located as close as possible to the low loss header to provide the closest control of temperature in the low loss header.

### **Required Parameter Changes**

Parameter	Function	Works Setting	Req'd Setting	Notes
16	Summer / Winter setting	17°C	As req'd	Outside temperature at which heating is turned off.
17	Heating curve setting	15	As req'd	Sets weather compensation at desired slope

## Weather Compensation Curve

The controller adjusts the flow temperature according to outside air temperature. Setting -- disables weather compensation (do not disable for this application). Settings for the curve are between 2.5 to 40. Increasing the slope will raise the flow temp more when the outside temp drops, decreasing the slope will raise the flow temp less when the outside temp drops.

TV Flow temperature  
TA Composite outside temperature

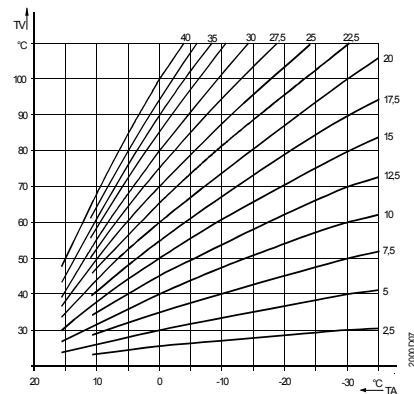

Example - A slope of 29 will provide 80°C flow temp at external air temp of -1°C

Parameter	Function	Works Set	Req'd Set	Notes
103	Min limit of flow temp setpoint	8°C	As req'd	Must be set to ensure non-condensing boilers don't condense
104	Max limit of flow temp setpoint	80°C	As req'd	Max flow temp regardless of external demand (Max 90°C)

**Note:** When used with constant temperature system Parameters 103 & 104 should be set to the same value. Suggested minimum for non-condensing boilers is 70°C which should ensure a minimum return temperature of 50°C under full load working conditions.

Parameter	Function	Works Set	Req'd Set	Notes
105	Type of building construction	1	As req'd	1 = heavy 0 = light
130	Lead boiler rotation	500 hrs	As req'd	Changes lead boiler after set time
133	Boiler switch-on delay	5 min	As req'd	Time delay between boiler modules starting
134	Boiler re-start delay	300 sec	As req'd	Time delay before boiler can restart after switch off.
170	Control input H1	0	2	Sets external control input for enable signal via VFC
171	Min flow temp setpoint for H1 enable signal	70°C	As req'd	Minimum flow temp for the time H1 contact is closed. Max 90°C

**Note:** During operation the cascade operating temperature set-point can be viewed at parameter 72. This parameter is read-only and displays the fixed flow temperature set-point or the compensated flow temperature set-point dependent on the settings made at parameter 17, 103 and 104. If the set-point requires adjusting this must be carried out at these parameters.

## Time Clock Settings

It is important when using this type of system that all the time periods are disabled to prevent operation when H1 contact is open. Time settings should be set as follows:

Parameter	Function	Works Set	Req'd Set	Notes
6	Start time period 1	06:00	-- : --	Disable clock
7	Finish time period 1	22:00	-- : --	Disable clock
8	Start time period 2	-- : --	-- : --	Disable clock
9	Finish time period 2	-- : --	-- : --	Disable clock
10	Start time period 3	-- : --	-- : --	Disable clock
11	Finish time period 3	-- : --	-- : --	Disable clock

Plant	RVA47		Param	LMU Blr 1	LMU Blr 2	LMU Blr 3
	Parameter	Address				
Address	140	1	605	2	3	4
Segment	141	0	606	0	0	0

Additionally each boiler module LMU controller must also be configured for cascade control by setting parameter 552 to 80. See section 3.1 for boiler parameter setting procedure

**PIPEWORK AND CONTROLS SCHEME FOR EXTERNAL SWITCHED ENABLE SYSTEMS**

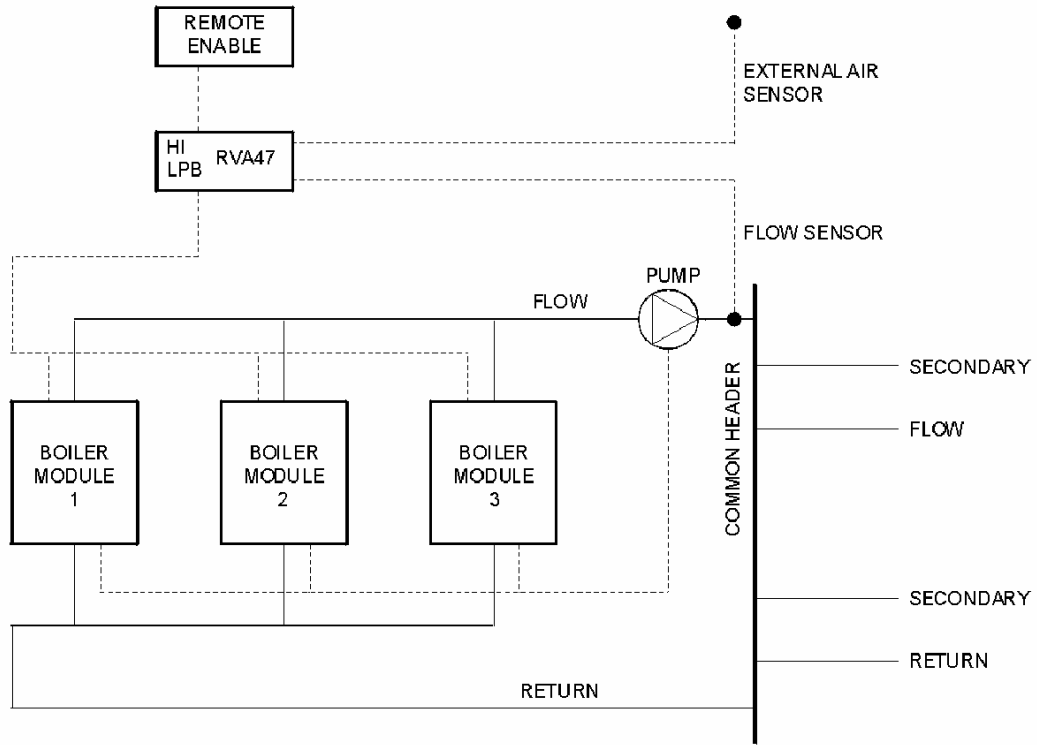

----- CONTROLS WIRING NOT SUPPLIED

**RVA47 WIRING SCHEMATIC FOR EXTERNALLY ENABLED SYSTEMS**

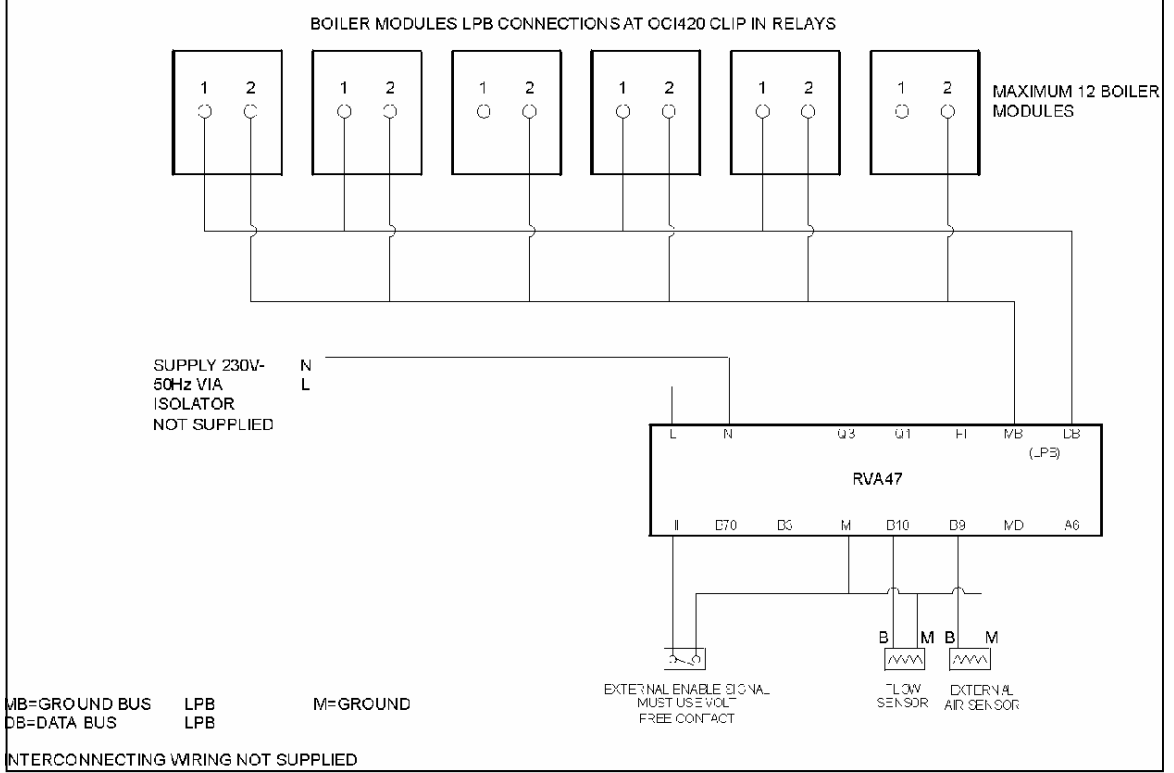

## **7.0 RVA47 Cascade Control Using Integral Time Clock**

### **Description of system type**

The RVA47 can cascade control up to 12 boilers. The controller regulates the primary circuit temperature according to the program set during commissioning. Control signal for the primary pump is from the boilers controls which activate their pump output signals when a heat demand is received from the cascade controller.

The operating range for the cascade can be set within the 5-90°C band limits. 90°C is the maximum because the LMU boiler control will override requests for higher operating temperatures.

### **Safety interlocks**

These circuits must be connected individually & directly to the boilers controller. In situations where the interlock circuit is triggered, by opening the contact on the LMU, the boiler will immediately shut down. During a safety interlock triggered shut down all functions that can enable the boiler are disabled, excluding frost protection.

### **Frost protection**

This is a function of the cascade controller and the boilers control. When frost protection as either a temperature requirement for the primary circuit or as an internal temperature requirement for the boiler is required, either the RVA47 or the boiler control will start the primary pump and initiate boiler operation.

### **Primary pump**

Control of the primary pump is derived from both the cascade controller and the boiler control. When a heat demand is required the cascade control signals the required boilers which in turn signal the pump to start prior to commencing their start up cycle. See wiring diagram in Appendix A at the rear of this manual.

It is good practice to equip pump controls with hand/off/auto switches for maintenance & commissioning. See primary pump wiring schematic in Appendix A.

### **Secondary circuits**

All secondary circuit functions are the responsibility of external controls and independent of the boiler cascade.

### **Hardware required**

1. Boiler cascade control kit. Flow sensor & pocket provided with kit must be used in this type of installation.
2. OCI420 Communication interface relay for fitting to boiler. Additional relays will be required for each boiler in excess of the standard 2 relays provided with the RVA47 boiler cascade control kit.
3. QAC34 External air sensor.
4. QAA10 Optional fixed setting room temperature sensor
5. QAA50 Optional adjustable room temperature sensor

### **Features available with this application type without room temperature sensor**

- Boiler cascade control & Lead boiler rotation
- Primary circuit temperature control according to internal program
- Display of Primary circuit temperature
- Display of fault codes, 2 most recent faults only
- 7 Day programmable time clock with 3 Programmable time periods per day
- Optimum start (must have external air sensor)
- Summer/winter changeover (must have external air sensor)
- Frost protection for boilers and primary circuit

### **Flow sensor**

The QAZ21 supplied with the cascade control kit must be fitted using the pocket provided. It should be located as close as possible to the low loss header to provide the closest control of temperature in the low loss header.



### Weather Compensation Curve

The controller adjusts the flow temperature according to outside air temperature. Setting -:- disables weather compensation (do not disable for this application). Settings for the curve are between 2.5 to 40. Increasing the slope will raise the flow temp more when the outside temp drops, decreasing the slope will raise the flow temp less when the outside temp drops.

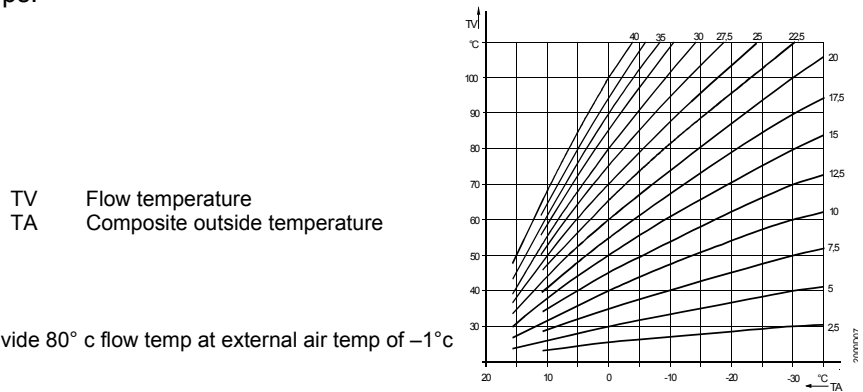

Example:- A slope setting of 29 will provide 80° c flow temp at external air temp of -1°c

Parameter	Function	Works Set	Req'd Set	Notes
103	Min limit of flow temp setpoint	8°C	As req'd	Must be set to ensure non-condensing boilers don't condense
104	Max limit of flow temp setpoint	80°C	As req'd	Max flow temp regardless of external demand (Max 90°C)

**Note:** When used with constant temperature system Parameters 103 & 104 should be set to the same value. Suggested minimum for non-condensing boilers is 70°C which should ensure a minimum return temperature of 50°C under full load working conditions.

Parameter	Function	Works Set	Req'd Set	Notes
105	Type of building construction	1	As req'd	1 = heavy 0 = light
130	Lead boiler rotation	500 hrs	As req'd	Changes lead boiler after set period of operation.
133	Boiler switch-on delay	5 min	As req'd	Sets time delay between boiler modules starting
134	Boiler re-start delay	300 sec	As req'd	Time delay before boiler can restart after switch off.
170	Control input H1	0	0	
171	Min flow temp setpoint for H1 enable signal	70°C	As req'd	Min flow temp for the time H1 contact is closed. Max 90°C

**Note:** During operation the cascade operating temperature set-point can be viewed at parameter 72. This parameter is read-only and displays the fixed flow temperature set-point or the compensated flow temperature set-point dependent on the settings made at parameter 17, 103 and 104. If the set-point requires adjusting this must be carried out at these parameters.

### Setting the clock

Note; the clock uses 24 hour time settings

00:00-23:59 For 24 hour running, period 1 only  
: — Inactive setpoint, use when setting is not required.

Parameter	Function	Works Set	Req'd Set	Notes
1	Time Setting	-	HH:MM	24 Hour clock
2	Day setting	-	1 - 7	1 = Mon, 7 = Sun
3	Date setting	-	01:01-31:12	Day : Month
4	Year setting	-	1999 - 2099	Year
5	Day selection	-	1 - 7 1... 7	Weekly program Daily program
6	Start time period 1	06:00	As req'd	24 hr clock
7	Finish time period 1	22:00	As req'd	24 hr clock
8	Start time period 2	— : —	As req'd	24 hr clock
9	Finish time period 2	— : —	As req'd	24 hr clock
10	Start time period 3	— : —	As req'd	24 hr clock
11	Finish time period 3	— : —	As req'd	24 hr clock

Parameter	Function	Works Set	Req'd Set	Notes
16	Summer / Winter setting	17°C	As req'd	Outside temperature at which heating is turned off.
17	Heating curve setting	15	As req'd	Sets weather compensation at the desired slope. See note **

Additional features available with this system type with optional room temperature sensor & external air sensor;

- Reduced temperature setpoint (night set back)
- Frost protection
- Optimum start according to room temperature & optimum stop
- Adaption of the heating curve

Parameter	Function	Works Set	Req'd Set	Notes
14	Reduced room temp setpoint	16°C	As req'd	Sets room temp required outside of heating period
15	Frost protection setting for room temp	10°C	As req'd	Sets room temp that initiates frost protection mode
100	Parallel displacement of heating curve	0.0	As req'd	Allows calibration of the room temp setting
106	Adaptation of heating curve	1	As req'd	0 = Adaptation inactive      1 = Adaptation active
107	Max forward shift for optimum	00:00	As req'd	Recalculates heating start time according to outside air temp
108	Max forward shift for optimum stop	00:00	As req'd	Recalculates heating stop time according to outside air temp

### Parallel displacement of the heating curve

Produces a parallel displacement of the heating curve in order to achieve a better match of room temperature setpoint and actual temperature. e.g. If a nominal room temperature setpoint of 20°C set on the controller always produces a room temperature of 22°C, displace the heating curve downward by 2°

TV    Flow temperature  
TA    Composite outside temperature  
TRw   Room temperature setpoint  
Forward shift for optimum start

00:00                      Optimum start control switched off  
00:10 to 06:00        Optimum start control switched on

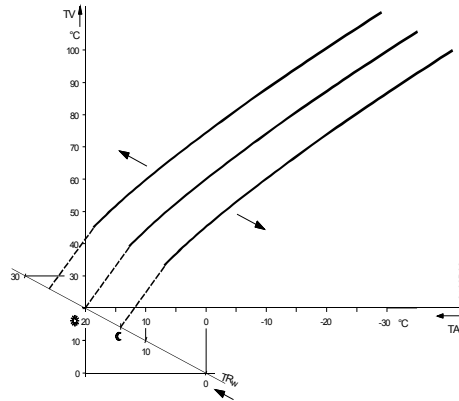

Plant	RVA47		Param	LMU Blr 1	LMU Blr 2	LMU Blr 3
	Parameter	Address				
Address	140	1	605	2	3	4
Segment	141	0	606	0	0	0

Additionally each boiler LMU controller must be configured for cascade control by setting 552 to 80. See section 3.1 for boiler parameter setting procedure

During operation the cascade operating temperature set-point can be viewed at parameter line 72. This parameter is read-only and displays the fixed flow temperature set-point or the compensated flow temperature set-point dependent on the settings made at parameter lines 17, 103 and 104. If the set-point requires adjusting this must be carried out at these parameters.

PIPEWORK AND CONTROLS SCHEME FOR INTERNAL TIME CLOCK CONTROLLED SYSTEMS

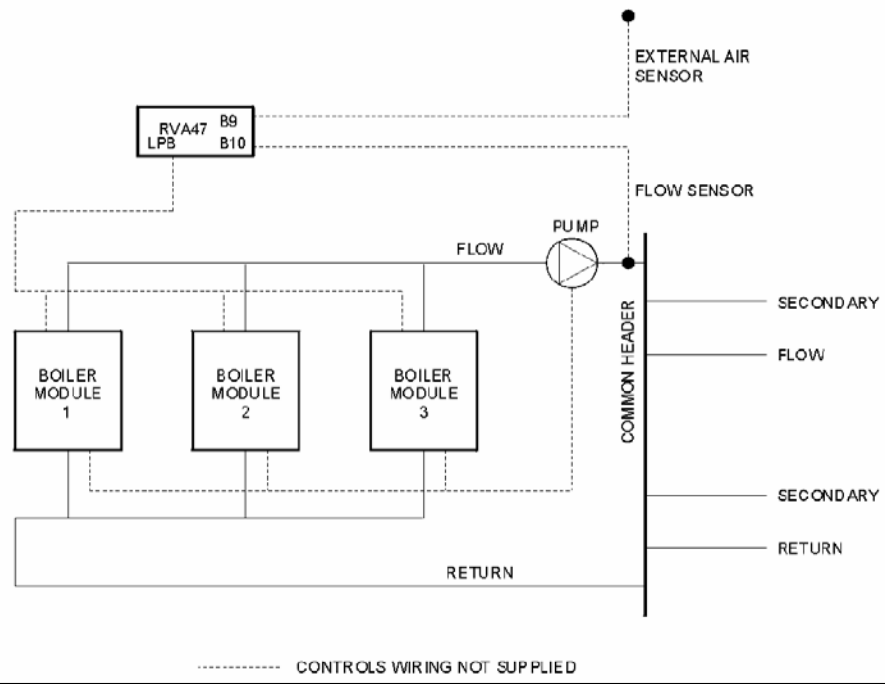

RVA47 WIRING SCHEMATIC FOR INTERNAL TIME CLOCK SYSTEMS

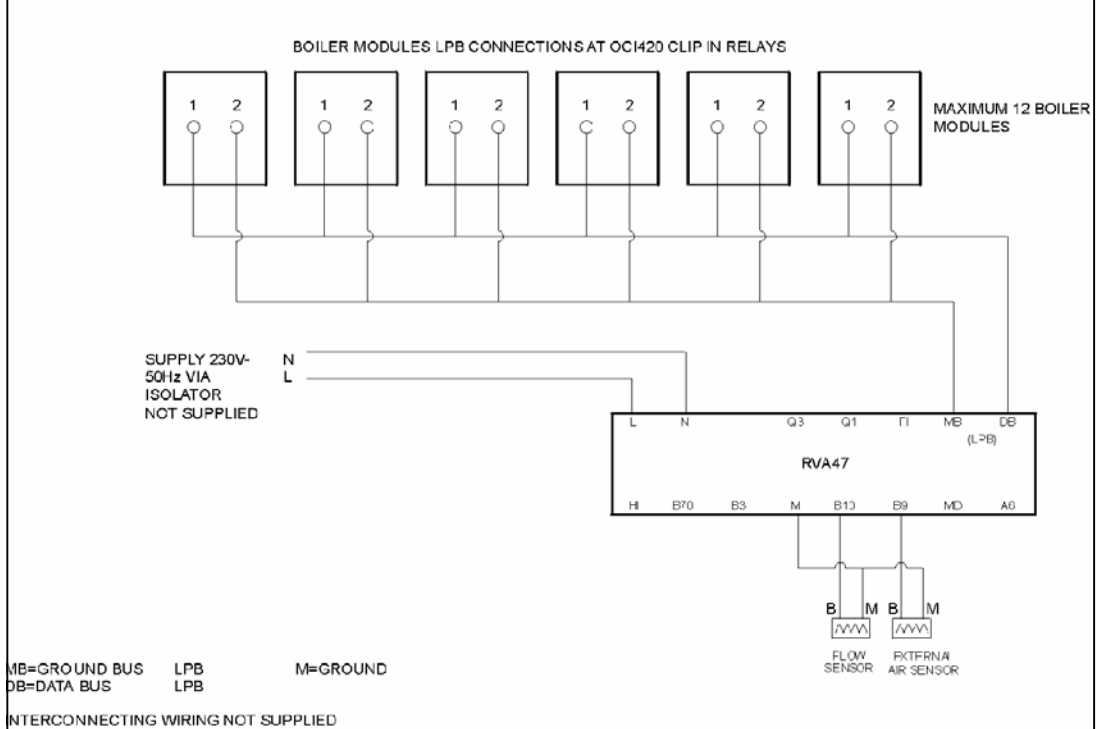

## **8.0 Cascade Control with Additional RVA46 Zone Controllers**

Operating at the command of the cascade control for up to 12 boilers can be achieved. Time and temperature regulation for the primary circuit is achieved via the RVA47 in accordance with the program set within the controller during commissioning. Control signal for the primary pump is derived from the boilers LMU controls which activate their pump output signal when a heat demand is received from the boiler cascade controller.

A domestic hot water cylinder may be controlled from the RVA47 cascade control. When the domestic hot water cylinder has a demand for heat the cascade control commences heating for the duration of the demand. At the end of the hot water cylinder demand the cascade will revert to providing heat to the heating circuits or shut down until a fresh demand for heat is received.

Additional zone controllers model RVA46 can be added to the cascade to provide time and temperature control for individual heating circuits. Where a heat demand is received from one of the zone controllers the cascade will commence heating to the required demand for that zone. Where more than one zone demands heat at the same time the cascade will produce heat to the highest demand value. In this situation mixing valve circuits operating at lower temperatures will modulate the mixing valve to ensure continuity of heat to the circuit, whilst constant temperature circuits with lower heat demands will have their pumps stopped during the higher demand.

The operating range for the cascade can be set within the 5-90°C band limits. 90°C is the maximum because the LMU boiler control will override requests for higher operating temperatures.

### **Safety interlocks**

These circuits must be connected individually and directly to the boilers LMU controller. In situations where the interlock circuit is triggered, by opening the contact on the LMU, the boiler will immediately shut down. During a safety interlock triggered shut down all functions that can enable the boiler are disabled except frost protection.

### **Frost protection**

This is a function of the RVA47 cascade controller and the boilers LMU control. When frost protection as either a temperature requirement for the primary circuit or as an internal temperature requirement for the boiler is required, either the RVA47 or the boiler LMU control will start the primary pump and initiate boiler operation.

### **Pump control**

Control of the primary pump is derived from both the RVA47 cascade controller and the boiler LMU control. When a heat demand is required the RVA47 signals the required boilers which in turn signal the pump to start prior to commencing their start-up cycle. All boilers must be on the same supply phase to prevent higher voltages being generated to the primary pump contactor. See wiring diagram in Appendix A at the rear of this manual.

Secondary circuit pumps receive a start signal from their relevant controller, either the RVA47 or RVA46.

It is good practice to equip pump controls with hand/off/auto switches for maintenance and commissioning purposes. All pumps should be switched via external contactors to prevent the pump load being drawn through the boiler controls or RVA controllers. Output signals for pumps are 230V 50Hz. See primary pump wiring schematic in Appendix A.

### **Secondary circuits**

Secondary circuits are controlled in the following manner;

**Domestic hot water circuit** control is derived through the RVA47. Both the cylinder sensor and pump output are connected to the RVA47. The RVA47 initiates heat production at the dictate of the domestic hot water time program and heat demand.

**Constant temperature circuit** control is derived from a RVA46 zone controller. Both the room temperature sensor and zone pump are connected to the RVA46. The cascade control initiates heat production at the dictate of the constant temperature circuit time program and heat demand.

**Variable temperature circuit** control is derived from a RVA46 zone controller. The room temperature sensor, zone pump, flow sensor and mixing valve are connected to the RVA46. The cascade control initiates heat production at the dictate of the variable temperature circuit time program and heat demand.

All zone controllers, RVA46, are connected to the boiler cascade controller, RVA47, via the LPB bus. When no heat demand signal is received from the zones at the RVA47 cascade controller the system is at rest.

### **Hardware required for primary circuit**

1. Boiler cascade control kit. Flow sensor & pocket provided with kit must be used with this type of installation.
2. OCI420 Communication interface relay - for fitting to each boiler. 1 Additional relay will be required for each boiler in excess of the standard 2 relays provided with the boiler cascade control kit.
3. QAC34 External air sensor

### Hardware required for D.H.W. secondary circuit

1. QAZ21 Immersion sensor

### Hardware required for C.T. secondary circuit

- 1 RVA46 Zone control kit The flow sensor in this kit is not required for a constant temperature circuit.
- 2 QAA10 Fixed setting room temperature sensor or, QAA50 adjustable setting room temperature sensor

### Hardware required for V.T. secondary circuit

- 1 RVA46 Zone control kit.
- 2 QAA10 Fixed setting room temperature sensor or, QAA50 adjustable setting room temperature sensor

### Features available with this system type

- Boiler cascade control & Lead boiler rotation
- Primary circuit temperature control according to internal program and zone heat demands
- Display of Primary circuit temperature
- Display of fault codes, 2 most recent faults only
- 7 Day programmable time clock with 3 Programmable time periods per day, per circuit
- Optimum start and stop for heating circuits
- Summer/winter changeover
- Frost protection for boilers, primary circuit, d.h.w. cylinder and zoned heating circuits
- Reduced temperature setpoint (night set back)
- D.H.W. Production via calorifier circuit
- Constant temperature circuit management
- Variable temperature circuit management

### Flow sensor

Supplied with the boiler cascade control kit must be fitted using the pocket provided. This should be located as close to the low loss header as possible to provide closest control of flow temperature in the low loss header.

### D.H.W. Cylinder sensors

The D.H.W. cylinder sensor QAZ21 is an immersion type and must be fitted in a pocket preferably located in the top portion of the calorifier.

Alternatively a mechanical switching thermostat may be used in place of the sensor. Thermostat terminals should be of ultra-low resistance, i.e. gold plated. Certain functions are not guaranteed when using a mechanical thermostat, i.e. reduced temperature set-point and d.h.w. cylinder frost protection. Preference for using a QAZ21 resistance sensor must therefore be given. See parameter line 125 in RVA47 for configuring type of sensor used.

### C.T. Circuit sensors

The C.T. circuit room sensor QAA10 or QAA50 dependent on type selected should be mounted in accordance with the instructions following.

### V.T. Circuit sensors

The V.T. circuit room sensor QAA10 or QAA50 dependent on type selected should be mounted in accordance with the instructions following.

The mixing valve flow sensor QAZ21 is an immersion type and must be fitted in a pocket positioned in accordance with the schematic diagram. A pocket is included in the RVA46 zone kit for this purpose.

Setting the clock – RVA47.320. Subsequent RVA46 controls adopt the time setting made on the RVA47.320 via the LPB Bus.

Note; the clock uses 24 hour time settings

Parameter	Function	Works Set	Req'd Set	Notes
1	Time Setting	-	HH:MM	24 Hour clock
2	Day setting	-	1 - 7	1 = Mon, 7 = Sun
3	Date setting	-	01:01 - 31:12	Day : Month
4	Year setting	-	1999 - 2099	Year

**Setting the heating circuit time clock program - RVA47**

Note: The time clock program uses 24 hour time settings.

All time settings must be set to inactive as heating times are dictated by the zone program requirements.

Parameter	Function	Works Set	Req'd Set	Notes
5	Day selection	-	1 - 7 1... 7	Weekly program Daily program
6	Start time period 1	06:00	—:—	24 hr clock
7	Finish time period 1	22:00	—:—	24 hr clock
8	Start time period 2	— : —	—:—	24 hr clock
9	Finish time period 2	— : —	—:—	24 hr clock
10	Start time period 3	— : —	—:—	24 hr clock
11	Finish time period 3	— : —	—:—	24 hr clock

— : — Inactive setpoint, use when setting is not required.

**Setting the D.h.w. circuit time clock program**

Setting the time clock program - RVA47 for D.h.w

Note: The time clock program uses 24 hour time settings

Parameter	Function	Works Set	Req'd Set	Notes
29	Day selection	-	1-7 1...7	Weekly program Daily program
30	Start time period 1	06:00	As req'd	24 Hour clock
31	Finish time period 1	22:00	As req'd	24 Hour clock
32	Start time period 2	— : —	As req'd	24 Hour clock
33	Finish time period 2	— : —	As req'd	24 Hour clock
34	Start time period 3	— : —	As req'd	24 Hour clock
35	Finish time period 3	— : —	As req'd	24 Hour clock

00:00 - 23:59 For 24 hour running, period 1 only      -: Inactive setpoint, use when setting is not required.

**Heating circuit zones time clock program**

Setting the time clock program - RVA46 for zone heating

Note: The time clock program uses 24 hour time settings

Parameter	Function	Works Set	Req'd Set	Notes
5	Day selection	-	1-7 1...7	Weekly program Daily program
6	Start time period 1	06:00	As req'd	24 Hour clock
7	Finish time period 1	22:00	As req'd	24 Hour clock
8	Start time period 2	— : —	As req'd	24 Hour clock
9	Finish time period 2	— : —	As req'd	24 Hour clock
10	Start time period 3	— : —	As req'd	24 Hour clock
11	Finish time period 3	— : —	As req'd	24 Hour clock

00:00 - 23:59 For 24 hour running, period 1 only      — : — Inactive setpoint, use when setting is not required.

### **Configuring the RVA47.320 for primary circuit and D.h.w. management**

Parameter	Function	Works Set	Req'd Set	Notes
13	D h w setpoint	55°C	As req'd	Recommended setting 60°C
17	Heating curve setting	15	As req'd	Disables weather compensation and heating circuit settings
103	Minimum limit of flow temperature setpoint	8°C	As req'd	This must be set to ensure that non condensing boilers do not condense
104	Maximum limit of flow temperature setpoint	80°C	As req'd	Flow temperature that cannot be exceeded regardless of external demand for heat.

Parameter lines 103 and 104 should be used to set the limit of flow temperature that will override requests from the heating zone controls.

Parameter	Function	Works Set	Req'd Set	Notes
120	Reduced setpoint d.h.w.	40°C	As req'd	Out-of-hours minimum d.h.w. storage temperature
121	Release of d.h.w. heating	1	2	Sets d.h.w. heating to time clock program
125	Type of d.h.w. sensor	0	As req'd	0 = Resistance sensor 1 = Mechanical stat
126	Boost of flow temperature setpoint	16°C	As req'd	Raises primary temp to d.h.w. setpoint plus boost setpoint i.e. 60+16=76°C
130	Lead boiler rotation	500 hrs	As Req'd	Changes lead boiler after set time period
133	Boiler switch-on delay	5 min	As req'd	Sets time delay between boiler modules starting
134	Boiler restart delay	300 sec	As req'd	Delay before boiler can restart after switching off

### **Configuring the RVA46 for Secondary Heating Zone Management**

Parameter	Function	Works Set	Req'd Set	Notes
14	Reduced room temp setpoint	16°C	As req'd	Room temperature required outside of heating period
15	Frost protection setting for room temperature	10°C	As req'd	Sets room temperature that initiates frost protection mode
16	Summer / winter setting	17°C	As req'd	Outside temperature at which heating is turned off
17	Heating curve setting	15	As req'd	Weather compensation to desired slope setting
64	Parallel displacement of heating curve	0.0	As req'd	Allows calibration of the room temperature setting
68	Min setting for flow temperature	8°C	As req'd	For non-condensing boilers recommended setting 70°C
69	Max setting for flow temperature	80°C	As req'd	Maximum setting 95°C

**Note:** When used with constant temperature system Parameters 68 & 69 should be set to the same value. Also when using non-condensing boilers Parameter 68 must be set to prevent the formation of condensation within the boiler. Suggested minimum setting in these conditions 70°C which should ensure a minimum return temperature of 50°C under full load working conditions.

Parameter	Function	Works Set	Req'd Set	Notes
70	Type of building construction	1	As req'd	1 = heavy 0 = light
73	Max forward shift for optimum start	00:00 HH:MM	As req'd	Recalculates heating start time according to outside air temperature
74	Max forward shift for optimum stop	00:00 HH:MM	As req'd	Recalculates heating stop time according to outside air temperature
87	Clock mode	0	1	Sets clock to match setting at cascade controller

**Room temperature set-point**

The setting for the room temperature is derived from the setting position of the knob on the front of the RVA46 zone controller. This provides the comfort setting only for the zone to which the zone controller is connected. In use the zone temperature can be remotely adjusted using the QAA50 room thermostat. Adjusting the knob on the front of the room thermostat creates an offset from the nominal set-point on the RVA46 controller. The maximum offset from the nominal set-point is +/- 3°C.

Using the small button located next to the setting knob on the room thermostat the zone can be switched between normal operation and night set back.

**Weather compensation curve**

The controller adjusts the flow temperature according to outside air temperature. Setting --- disables weather compensation (only disable if using 0-10v analog input). Settings for the curve are between 2.5 to 40. Increasing the slope will raise the flow temp more when the outside temp drops, decreasing the slope will raise the flow temp less when the outside temp drops.

TV Flow temperature  
TA Composite outside temperature.

Example. A slope setting of 29 will provide 80°C flow temp at external air temp -1°C  
Forward shift for optimum start chart

00:00 Optimum start control switched off

00:10 to 06:00 Optimum start control switched on

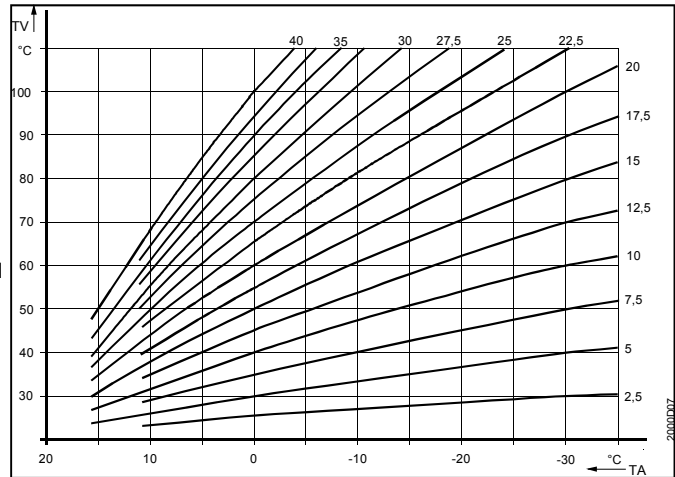

**Parallel displacement of the heating curve**

Produces a parallel displacement of the heating curve in order to achieve a better match of room temperature setpoint and actual temperature.

E.g. If a nominal room temperature setpoint of 20°C set on the controller always produces a room temperature of 22°C, displace the heating curve downward by 2°

TV Flow temperature  
TA Composite outside temperature  
TRw Room temperature setpoint

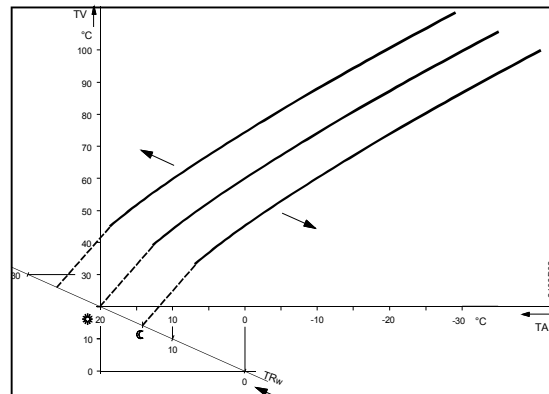

**Plant Addresses**

Plant	RVA47		Param	LMU Bir 1	LMU Bir 2	LMU Bir 3
	Parameter	Address				
Address	140	1	605	2	3	4
Segment	141	0	606	0	0	0

Subsequent boilers will be addressed as the next following number in the LMU boiler controller. Zone controllers type RVA46 should be addressed to follow after the boiler addresses. See example below.

Plant	Param	LMU Bir 1	LMU Bir 2	LMU...	LMU Bir 12	Param	RVA46
Address	605	2	3	XX	13	85	14
Segment	606	0	0	0	0	86	0



**Note:** Additional zone controllers RVA46 adopt consecutive numbers for device address. Maximum number of addresses per segment = 16

Each boiler LMU controller must be configured for cascade control by setting parameter 552 to 80. See section 3.1 for boiler parameter setting procedure

During operation the cascade operating temperature set-point can be viewed at parameter 72. Parameter 72 is read-only and displays fixed flow temperature set-point or compensated flow temperature set-point dependent on the settings made at parameter lines 17, 103 and 104. Set-point adjustment is carried out at these parameters.

Flow temperature set-point for an individual heating zone is viewed at parameter 63 of the respective RVA46. Parameter 63 is read only and displays fixed flow temperature set-point or compensated flow temperature set-point dependent on settings made at parameter 17, 68 & 69. Adjustment is carried out at these parameters.

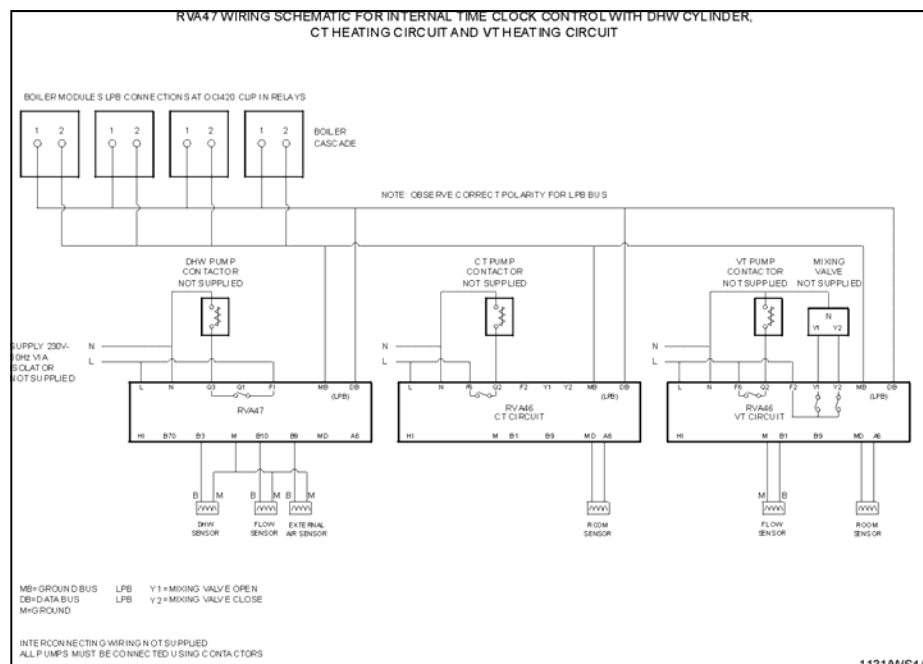
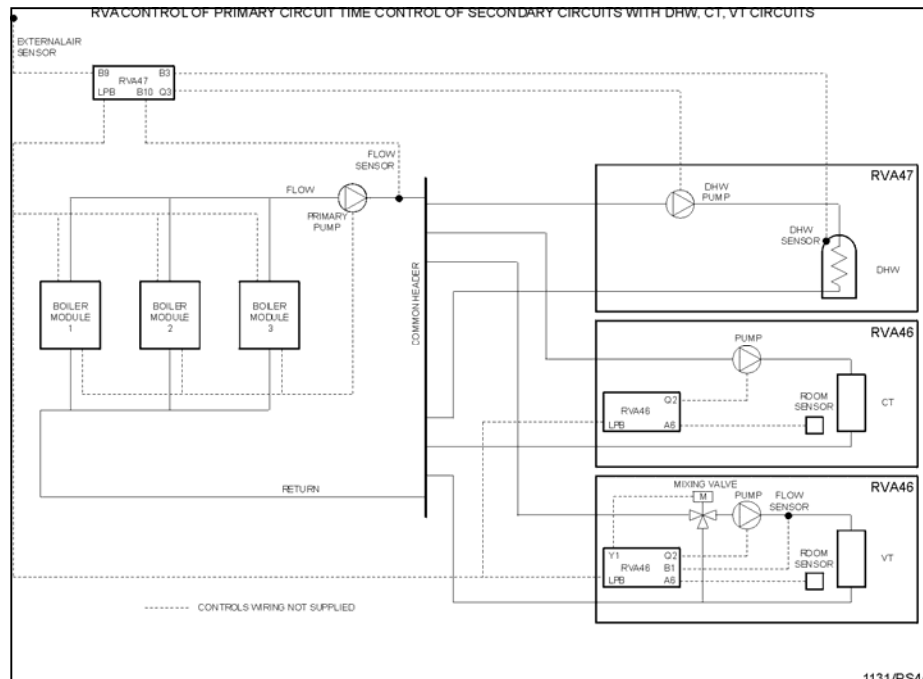

**APPENDIX A: Wiring for Primary Pump when using Cascade Controller**

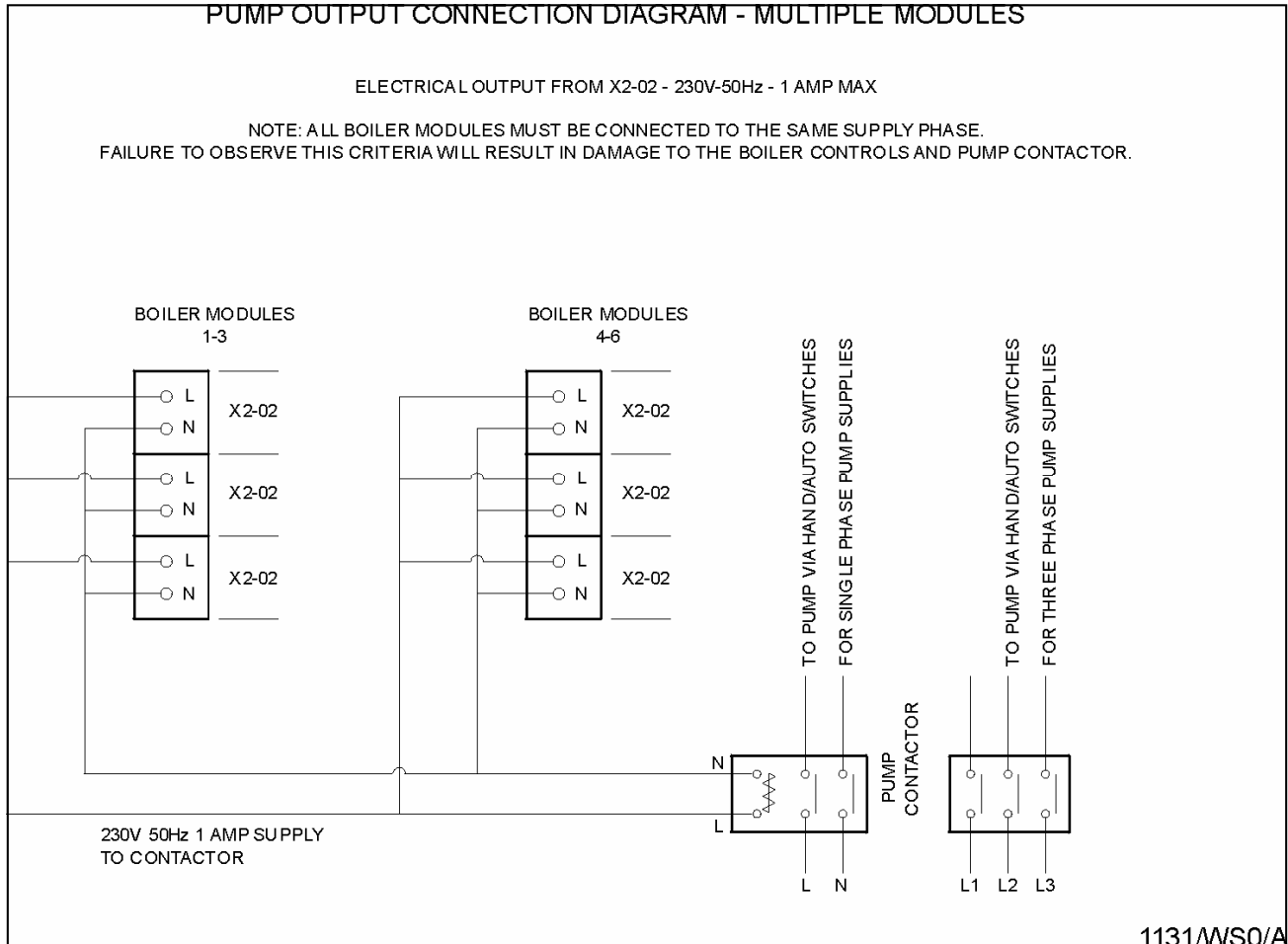

## APPENDIX B: Sensors

### B1.1 External Air Sensor QAC34

The outside sensor has a plastic housing with a removable cover. The sensing element is embedded in synthetic resin. The connection terminals are accessible after removal of the cover. To introduce the cable through the wall, a grommet, cable gland or sealing compound is required (also refer to illustration below). For wall mounting, a cable entry gland can be fitted to the bottom of the housing.



Type Ref	Sensing Element	Range (°C)	Tolerance (K*)	Time Constant (min)	Weight (g)	Copper Cable (mm <sup>2</sup> ) / Cable Dia (mm)	Perm. Cable Length (m)
QAC34	NTC575Ω at 20°C	-50... 60	± 1	12	73	1.0 / 6.6	80

\* QAC34 at -10 - +C. The sensing element is an NTC resistor with a resistance of 1000Ω at 25°C. The resistance drops at about 4% per °c.

#### Mounting Position:

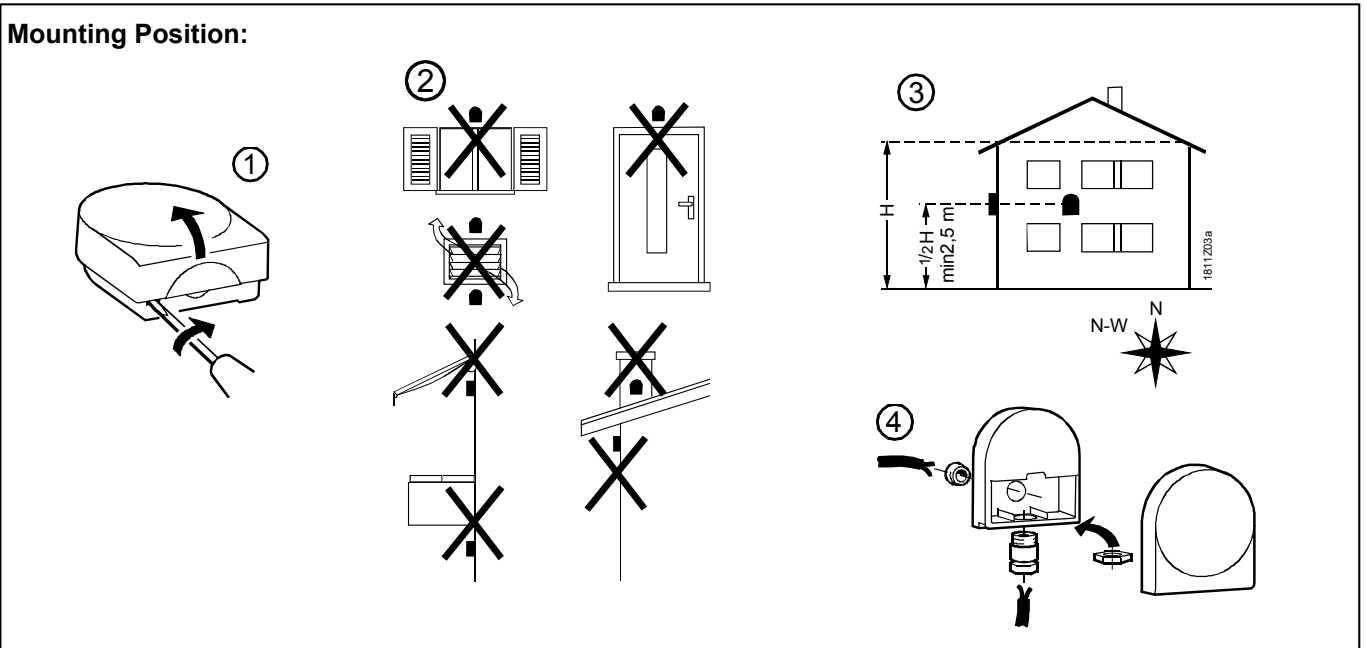

#### Dimensions:

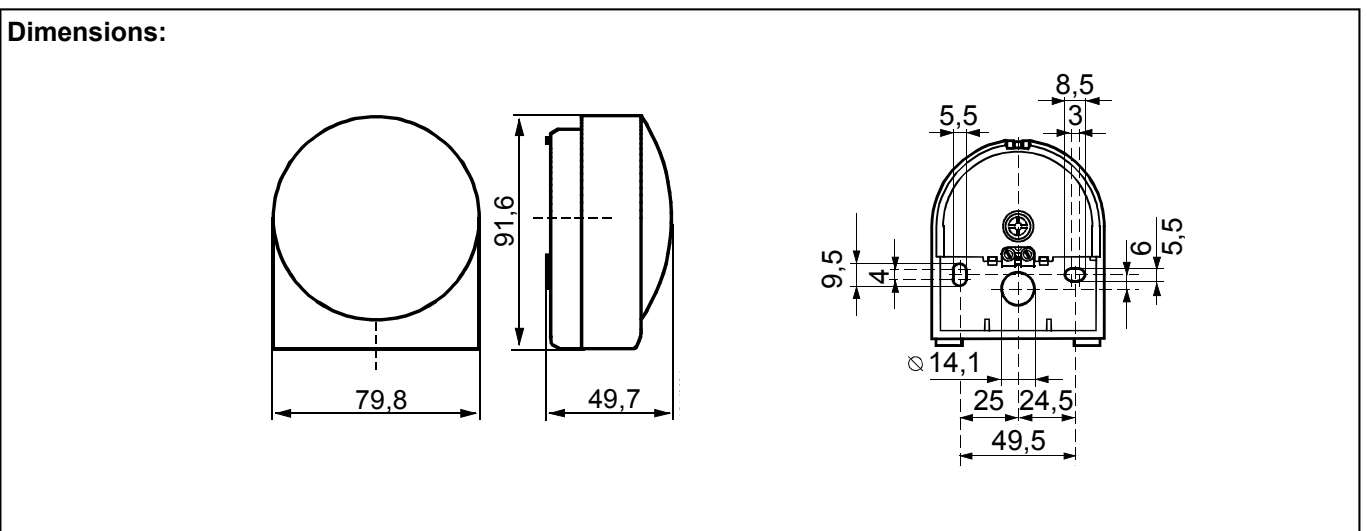

## B1.2 Room Temperature Sensors

### QAA10 Non adjustable room temperature sensor

For use where there is a significant risk of unauthorised adjustment as no adjustment can be made to the nominal room temperature set-point. The sensor transmits the actual temperature to the RVA46 controller where the nominal room temperature set-point is programmed.



### QAA70 Programmable room temperature sensor

For use where there is a low risk of unauthorised adjustment. The sensor transmits the actual room temperature to the respective RVA46 controller where the setting for required nominal room temperature set-point may be programmed. Additionally 3 heating periods can be programmed from the sensor for each day of the week. The nominal room temperature set-point can also be programmed and an offset from this value can be made using the knob on the front of the room sensor. This offset provides a maximum +/- 3°C deviation from the setting in 1/2 °C increments. It also features a programmable holiday function, night set back temperature setting, and a programming lock function to prevent unauthorised adjustments.



### QAA50 Adjustable room temperature sensor

Designed for use where there is a low risk of unauthorised adjustment. The sensor transmits the actual room temperature to the respective RVA46 controller where the setting for required nominal room temperature set-point is programmed. Additionally the sensor allows for an offset from the programmed nominal room temperature set-point to be made. This offset provides a maximum +/- 3°C deviation from the setting in 1°C increments. Using a small button located next to the setting knob on the room thermostat the zone can be switched between normal operation and night set back.



### Location - All Sensor Types

In the main occupancy room or reference room. The location of installation should be chosen so the sensor can capture the room temperature as accurately as possible without being affected by direct solar radiation or other heating or cooling sources. Height should be approximately 1.5 meters. The units can be fitted to most commercially available recessed conduit boxes or directly on the wall.

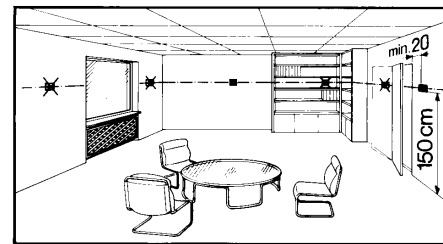

### Installation - QAA10 and QAA50

Wall or Boiler control panel (with the help of clips)  
The controller may not be exposed to dripping water  
Permissible ambient temperature: 0...50 °C

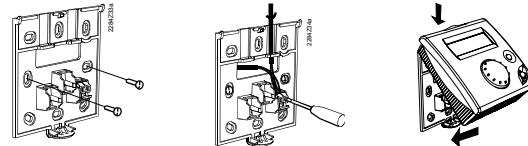

### Installation - QAA70

Wall or Boiler control panel (with the help of clips)  
The controller may not be exposed to dripping water  
Permissible ambient temperature: 0...50 °C

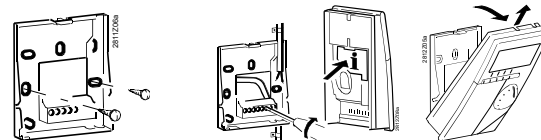

### Electrical Connections

The room sensors are powered from the controller via the dedicated cable for power and communication. This must be a 2 core cable of minimum c.s.a. 0.5mm<sup>2</sup>, maximum c.s.a. 1.5mm<sup>2</sup>. Maximum cable length 75 m. The wiring must be connected to the RVA46 controller using the dedicated blue twin terminal connector supplied with the RVA46 zone control kit. No other wiring is to be connected to these terminals.

**QAA10 Wiring must be connected as follows:**

Room Thermostat	RVA46 Zone Controller
1 PPS	A6
2 G0	MD



**QAA50 Wiring must be connected as follows:**

Room Thermostat	RVA46 Zone Controller
1 A6	A6
2 MD	MD

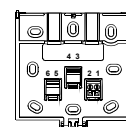

**QAA70 Wiring must be connected as follows:**

Room Thermostat	RVA46 Zone Controller
1 A6	A6
2 MD	MD

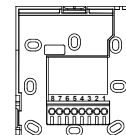

## Appendix C – Technical Data

### C1.1 Technical data for RVA47.320 Boiler Cascade Controller

#### Power supply

Nominal voltage	AC 230 V ( $\pm 10\%$ )
Nominal frequency	50 Hz ( $\pm 6\%$ )
Power consumption	max. 7 VA

#### Requirements

Safety class	II, to EN 60 730 (when mounted properly)
Degree of protection	IP 40 to EN 60 529 (when mounted correctly)
Electromagnetic immunity	Conforming to the requirements of EN 50 082-2
Electromagnetic emissions	Conforming to the requirements of EN 50 081-1

#### Climatic conditions

Operation to IEC 721-3-3	Class 3K5 (non-condensing)
Temperature	0...50 °C
Storage to IEC 721-3-1	Class 1K3 -25...70 °C
Transport to IEC 721-3-2	Class 2K3 -25...70 °C

#### Contamination

To EN 60 730	Usual environment
--------------	-------------------

#### Mechanical conditions

Operation to IEC 721-3-3	Class 3M2
Storage to IEC 721-3-1	Class 1M2
Transport to IEC 721-3-2	Class 2M2

#### Mode of operation

To EN 60730 par. 11.4 11.4	1b
----------------------------	----

#### Output relays

Voltage range	AC 24...230 V
Nominal current	AC 0.02...2 (2) A
Switch-on peak	max. 10A for max 1s
Fusing	max. 10A

#### Bus extension

Perm. cable length for LPB: (copper cable 1.5 mm <sup>2</sup> , 2-wire <b>not</b> interchangeable)	
With controller bus power supply (per controller)	250 m
With central bus power supply (bus power supply / controller)	460 m
Bus loading number	E = 3

#### Permissible sensor cable lengths

0.6 mm dia.	max. 20 m
1.0 mm <sup>2</sup>	max. 80 m
1.5 mm <sup>2</sup>	max. 120 m

#### Inputs

outside temperature sensor	NTC (QAC31) or Ni 1000 (QAC21)
D.h.w. sensor	Ni 1000 W at 0 °C (QAZ21)
Cascade flow temperature sensor	Ni 1000 W at 0 °C (QAD21)
H1 as an analog input with safety extra low voltage (SELV)	$U_{H1} = (12...24)$ V (contact open)
	$I_{H1} = (2...5)$ mA (contact closed)
H1 as an analog input with safety extra low voltage (SELV)	$U_{in} = (0...10)$ V for 0...130 °C
	$R_{in} = 100$ kW
	max. ratings 20 V; 20mA

#### Miscellaneous

Backup of time switch	> 12 hours
-----------------------	------------

## C1.2 Technical data for RVA46 Heating Zone Controller

### Power supply

Nominal voltage	AC 230 V ( $\pm 10\%$ )
Nominal frequency	50 Hz ( $\pm 6\%$ )
Power consumption	max. 7 VA

### Requirements

Safety class (when mounted properly)	II, to EN 60 730
Degree of protection (when mounted correctly)	IP 40 to EN 60 529
Electromagnetic immunity	Conforming to the requirements of EN 50 082-2
Electromagnetic emissions	Conforming to the requirements of EN 50 081-1

### Climatic conditions

Operation to IEC 721-3-3 Temperature	Class 3K5 (non-condensing) 0...50 °C
Storage to IEC 721-3-1	Class 1K3-25...70°C
Transport to IEC 721-3-2	Class 2K3-25...70°C

### Mechanical conditions

Operation to IEC 721-3-3	Class 3M2
Storage to IEC 721-3-1	Class 1M2
Transport to IEC 721-3-2	Class 2M2

### Mode of operation

To EN 60730 par. 11.4 11.4	1b
----------------------------	----

### Output relays

Voltage range	AC 24...230 V
Nominal current	AC 0.02...2 (2) A
Switch-on peak	max 10A for max.1s
Fusing	max. 10 A

### Bus extension

Perm. cable length for LPB: (copper cable 1.5 mm <sup>2</sup> , 2-wire not interchangeable) With controller bus power supply (per controller)	1400 m
Bus loading number	E = 3

### Permissible sensor cable lengths

0.6 mm dia.	max. 20 m
1.0 mm <sup>2</sup>	max. 80 m
1.5 mm <sup>2</sup>	max. 120 m

### Inputs

Outside temperature sensor	NTC (QAC31)	or
	Ni 1000 (QAC21)	
Flow temperature sensor	Ni 1000 W at 0 °C	(QAD21)

### Miscellaneous

Backup of time switch	> 12 hours
Weight	approx. 0.5 kg
Software class to EN 60 730	class A

## **Appendix D: Commissioning RVA46 Heating Circuit Controller**

The controller has 98 different parameters which can be examined or set. These are separated into 2 groups End User (1-50) and Heating Engineer (51-98)

The parameters can be accessed and programmed in the same ways as the RVA 47 detailed in section 3.1

### **Commissioning checks**

- Ensure the mounting and electrical installation are in compliance with the relevant requirements.
- Set plant-specific settings as described in section "Parameter settings".
- Reset the attenuated outside temperature by pressing the — & + buttons for 3 seconds in parameter 19.
- Access parameter 51 (Heating Engineer Group) and press the — or + buttons to cycle through and check the following settings:
  - 0– Control mode according to the operational status
  - 1– All outputs OFF
  - 2– Heating circuit pump Q2
  - 3– Mixing valve open Y1
  - 4– Mixing valve closed Y2
- Access parameter 52 (Heating Engineer Group) and press the — or + buttons to cycle through and check the following readings:
  - 0– Flow sensor
  - 1– Outside sensor
  - 2– Room sensor
  - 3– Display of input

## Enduser Parameter settings for the RVA46.531 Heating Circuit Controller

The table below shows the parameters to be set or adjusted in the controller. The procedure for setting these is shown in section 3.1

Line	Function	Range	Unit	Resolution	Works Set
<b>Setting the Clock</b>					
1	Time of Day	0... 23:59	h/min	1 min	00:00
2	Weekday	1... 7	Weekday	1 day	1
3	Date (day, month)	01.01... 31.12	Dd.MM	1	-
4	Year	1999... 2099	jjjj	1	-
<b>Time Switch Program 1</b>					
5	Weekday - pre-selection heating circuit 1-7 7-day block 1... 7 Individual days	1-7 / 1...7	Weekday	1 day	-
6	Switch-on time 1. period	—:—... 24:00	h/min	10 min	06:00
7	Switch-off time 1. period	—:—... 24:00	h/min	10 min	22:00
8	Switch-on time 2. period	—:—... 24:00	h/min	10 min	—:—
9	Switch-off time 2. period	—:—... 24:00	h/min	10 min	—:—
10	Switch-on time 3. period	—:—... 24:00	h/min	10 min	—:—
11	Switch-off time 3. period	—:—... 24:00	h/min	10 min	—:—
<b>D.h.w</b>					
12	Operating mode of d.h.w heating 0 Off 1 ON	0 / 1	-	1	1
13	Nominal setpoint pf the d.h.w. temperature (TBWw) TBWR Line 80 TBWmax Line 34 (OEM)	TBWR...TBWmax	°C	1	55
<b>Heating Circuit</b>					
14	Reduced room temperature setpoint (TRRw) TRF Frost protection setpoint of room temperature TRN Setpoint knob heating circuit	TRF...TRN	°C	0.5	16
15	Frost protection setpoint of the room temperature (TRFw) TRRw Line 14	4...TRRw	°C	0.5	10
16	Summer / winter changeover temperature (THG1)	8...30	°C	0.5	17
17	Heating curve slope -:— Inactive 2.5...40 Active	-:— / 2.5...40	-	0.5	15
18	Actual value of the room temperature (TRx)	0...50	°C	0.5	-
19	Actual value of the outside temperature (TAX) To set the attenuated outside temp. to TAX, press the +/- buttons simultaneously for 3 seconds	-50...+50	°C	0.5	-
<b>Standard Values</b>					
23	Standard times To activate, press the + and - buttons simultaneously for 3 seconds.	-	-	-	-
<b>Service Values</b>					
50	Indication of faults	0...255	-	1	-
51	Output test 0 Control mode according to the operational status 1 All outputs OFF 2 Heating circuit pump Q2 3 Mixing valve open Y1 4 Mixing valve closed Y2	0... 4	-	1	0
52	Input Test 0 Flow sensor B1 1 Outside sensor B9 2 Room sensor A6 3 Display of input H1	0... 3	-	1	0



## Heating Engineer Parameters overview for the RVA46.531 Heating Circuit Controller (continued)

Line	Function	Range	Unit	Resolution	Factory Setting
53	Display of plant type	1... 16	-	1	-
54	Display of the nominal room temperature setpoint Nominal setpoint incl. Room unit readjustment	0... 35	-	1	-
55	Actual value of flow temperature (TVx) Input B1	1... 140	°C	1	-
56	Actual value of d.h.w. temperature (TBWx) BMU	0... 140	°C	1	-
57	Actual value of boiler temperature (TKx) BMU	0... 140	°C	1	-
58	Attenuated outside temperature (TAXged)	-50... +50	°C	0.5	-
59	Composite outside temperature (Taxgem)	-50... +50	°C	0.5	-
60	Indication of BMU error code 0... 255 Error Code	0... 255	-	1	-
61	Actual value of common flow temperature	0... 140	°C	1	-
62	Display of PPS communication — — No communication 000 Communication line with short circuit 0... 15 Address (display on the left) Device identification (display on the right)	0... 15 / 0... 255 — / 000	-	1	-
63	Flow temperature setpoint (TVw)	0... 140	°C	1	-
<b>Heating Circuit</b>					
64	Parallel displacement of heating curve	-4.5... +4.5	°C (K)	0.5	0.0
65	Room influence 0 Inactive 1 Active	0 / 1	-	1	1
67	Switching differential of the room temperature (SDR) — - Inactive 0.5... 4.0 Active	— : -... 4.0	°C (K)	0.5	— :-
68	Minimum limitation of flow temperature setpoint (TVmin) TVmax Line 69	8... TVmax	°C	1	8
69	Maximum limitation of flow temperature setpoint (TVmax) TVmin Line 68	TVmin... 95	°C	1	80
70	Type of building construction 0 Heavy 1 Light	0 / 1	-	1	1
71	Adaptation of heating curve 0 Inactive 1 Active	0 / 1	-	1	1
73	Maximum forward shift of optimum start control 0 No forward shift	00:00... 06:00	hh:mm	10 min	00:00
74	Maximum forward shift of optimum stop control 0 No forward shift	00:00... 06:00	hh:mm	10 min	00:00
76	Gain of locking signal	0... 200	%	1	100
77	Floor curing dates 0 Off 1 Functional heating 2 Floor curing heating 3 Functional and floor curing heating	0... 3	-	1	0
78	Floor curing dates Day Flow temperature setpoint	0... 32 0... 95	- °C	1	-
<b>D.h.w.</b>					
80	Reduced setpoint of d.h.w. temperature (TBWR) TBWw Line 13	8... TBWw	°C	1	40
81	d.h.w. heating programme 0 24 h/day 1 System heating program(s) with forward shift	0... 1	-	1	1

## Overview of Heating Engineer Parameters: RVA46.531 Heating Circuit Controller (continued)

<b>D.h.w.</b>					
82	Assignment of d.h.w. heating 0 Local heating circuit 1 All heating circuits in the system 2 All heating circuits in the system	0... 2	-	1	2
<b>LPB / System</b>					
85	LPB device address 0 Standalone 1... 16 Device address (system)	0... 16	-	1	0
86	LPB segment address 0 Heat source segment 1... 14 Heat consumption segments	0... 14	-	1	0
87	Clock mode 0 Autonomous clock 1 System time with remote adjustment 2 (system time with adjustment) 3 System clock (master)	0... 3	-	1	0
88	BMU ECO-Switch 0 No Action 1 Acting on the heating circuits	0 / 1	-	1	0
89	Range of action of central changeover 0 In the segment 1 In the system (if segment address = 0)	0 / 1	-	1	1
90	Winter- / summertime changeover	01.01... 31.12	tt.MM	1	25,03
91	Summer- / wintertime changeover	01.01... 31.12	tt.MM	1	25.10
92	LPB power supply 0 Off (central bus power supply) 1 Auto (bus supply via controller)	0 / 1	-	1	1
93	Display of LPB power supply	On / OFF	-		-
94	Display of LPB communication	On / OFF	-		-
95	Outside temperature source — No signal 00.01... 14.16 Address	— / 00.01... 14.16	-	1	-
<b>Display of Input H1</b>					
96	Input H1 0 Changeover of operating mode of all HK and d.h.w. 1 Changeover of operating mode of all HK 2 Minimum flow temperature setpoint (TVHw)	0... 2	-	1	0
97	Minimum flow temperature setpoint contact H (TVHw)	8... 95	°C	1	70
98	Operation of Contact H1 0 N.C. 1 N.O.	0 / 1	-	1	1

**Operation**

**Operation: RVA46.531 Heating Circuit Controller**

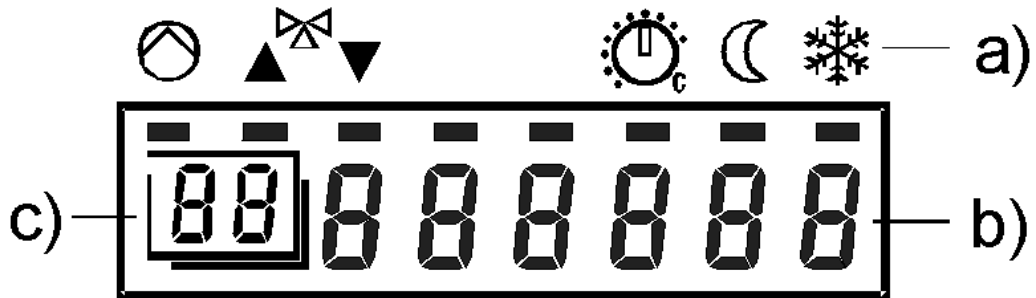
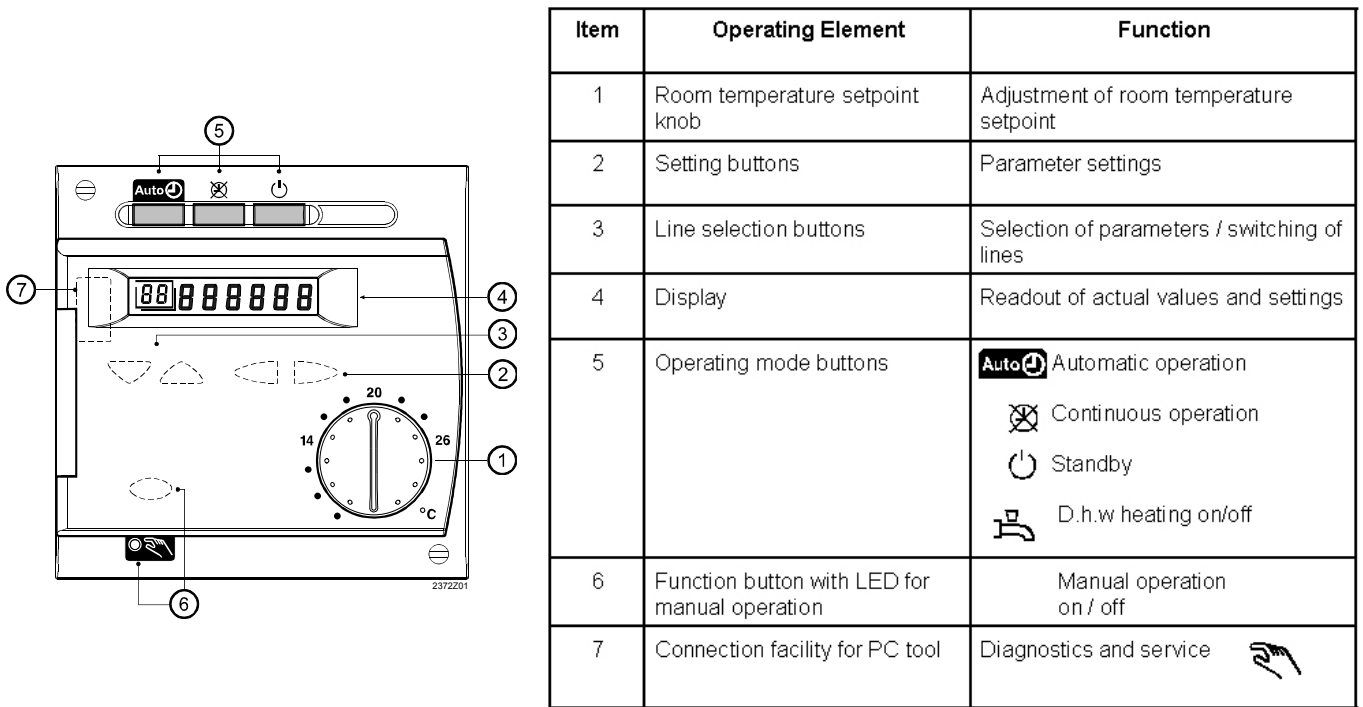

- a) Symbols for indicating the operational status with the black pointer.
- b) Display during normal control mode or when making settings.
- c) Programming line when making settings

Figure D1.2

## Operational fault finding: RVA46 Zone controller

### No display on the controller:

- Is the heating plant's main switch turned on?
- Are the fuses in order?
- Check the wiring

### Heating control does not function. There is no display time, or time displayed is incorrect:

- Check fuses of the plant
- Make a reset: Isolate controller from mains supply for about 5 seconds
- Set the correct time of day on the controller (operating line 1).
- Check the time of day on the clock time master if the controller is used in a system

### Regulating unit does not open / close, or does not operate correctly:

- Manual lever of controlling element may not be engaged
- Wiring to the controlling element interrupted (output test)
- Check wiring of the sensors (input test)
- Quick setback or automatic 24-hour heating limit is active
- Check the settings

### Heating circuit pump does not run:

- Is the right type of plant displayed? (param 53)
- Check wiring and fuse (output test)
- Check wiring of the sensors (input test)
- Check the settings

### Pump does not run

- Check wiring and fuse (output test)
- Check wiring of the sensors (input test)

### The room temperature does not agree with the required temperature level:

- Check the room temperature setpoints
- Is the required operating mode indicated?
- Is auto operation overridden by room unit?
- Are weekday, time & heating program correct?
- Has heating curve slope been correctly set?
- Check wiring of outside sensor

### Heating plant does not function properly:

- Check parameters based on "Heating engineer" & "End-user" instructions.
- Carry out the input test
- Carry out the output test
- Check electromechanical control stat (TR) & manual reset safety limit stat (STB)

### Frost protection for the plant does not function at all, or does not function correctly:

- Check correct functioning of the pumps

### Quick setback or boost heating does not operate:

- Check settings made on heating engineer's level
- Check the sensor connected to A6 (input test)

### Error message; display shows 'ER'

The controller will indicate that a fault has occurred within the controller itself or within the system to which it is attached. In normal operation the controller display indicates, 'Er', when a fault has occurred. As indicated below.

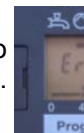

The error message code is stored at parameter line, '50', in the respective controller. To access the error code use the navigation buttons, , until the screen display shows parameter 50 as shown below.

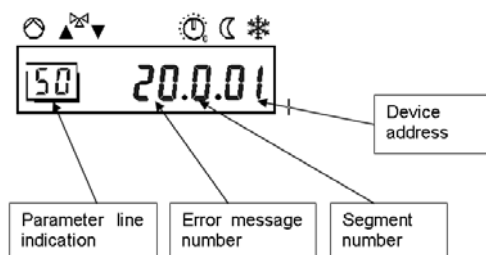

**Error message number:** can be interpreted using the error message table on the next page  
**Segment number:** segment address of the faulty device. There may be up to 14 operating segments in a system. Segments 10-14 are indicated by letter A, B, C, D, E.  
**Device address** indicates which device within the operating segment is at fault.

**Note:** Segment number and address number will not be shown when the fault is associated with the device being interrogated only when the fault is associated with an alternative device within the system.

The controller can store and indicate a maximum of 2 error messages. By using the navigation buttons  it is possible to scroll between the error message numbers should more than 1 fault be present. The fault will remain indicated until the cause of the fault has been rectified

Error message table	
Error message N°	Description of fault
Blank	No Fault
10	No communication with outside air temp sensor: No sensor fitted, faulty sensor or wiring.
30	No communication with zone flow temperature sensor: No sensor fitted, faulty sensor or wiring.
61	Fault with room temp sensor: Faulty sensor or wiring.
81	Fault with , 'BUS', communication between devices: Possible short, incorrect polarity or wiring fault.
82	Address collision: Two or more devices with the same address.
86	Short circuit with , 'PPS', system: Wiring fault to room sensors.
100	2 or more master clocks set within system.
140	Inadmissible LPB device or segment number: Check segment addresses.
145	Incorrect device connected to , 'PPS', system: Incorrect device connected to room sensor terminals.
150	General boiler fault. See error codes in boiler manual.

## APPENDIX E - Operating QAA70 Programmable Room Sensor

Room unit is on if power is present. A heating engineer can change parameter settings to meet individual needs. If, with weather compensation and room temperature influence (controller setting), the room is equipped with a thermostatic radiator valve, the latter must be locked in its fully open position, thus ensuring maximum flow through the radiator.

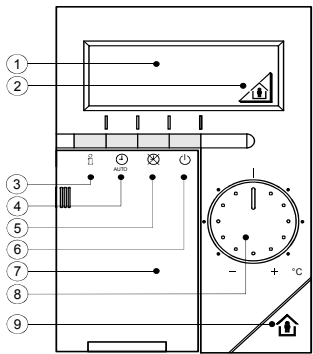

### Operating Elements

### Display Elements

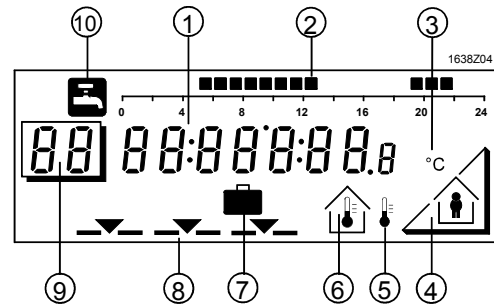

1. Display
2. Display presence button
3. Info Button
4. Operating mode button, automatic mode
5. Operating mode button, manual operation
6. Operating mode button, standby
7. Cover
8. Temperature setting knob
9. Presence button

1. Digital display, clock
2. Heating program
3. Units (°C)
4. Display presence button
5. Outside temperature
6. Room temperature
7. Holiday function
8. Operating mode
9. Line number / current day
10. D.h.w. temperature

### Operating the Unit

**Caution:** Before any commissioning or operational adjustments to the room sensor the relevant RVA controller to which the unit is connected must be in 'AUTO' mode. Should the relevant RVA controller be in standby or time clock override the room controller will not be permitted to enter programming mode!

During operation, the unit cover must be closed!

### Selecting the operating mode

Press the required operating mode button. To select one of the following modes:

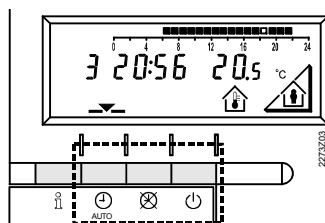

**Automatic Mode:** The heating operates automatically according to the selected heating program. The program can be temporarily overridden by pressing the presence button.



**Manual Operation:** Heating system is operated manually, depending on the choice made with the presence button.



**Standby:** Heating is switched off. Frost protection is ensured

The above selections do not affect the d.h.w. Operating mode.

### Info Button

When the info. Button is pressed, the display shows the following values in successive order;

Weekday, time of day, room temperature

Weekday/time of day

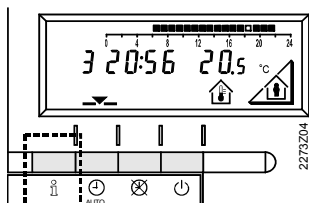

Outside temperature (only appears if outside temp sensor is connected)



The room unit continues to operate independent of the selected display.

## Temperature Readjustments

Before making any room temperature readjustments on the room unit, thermostatic radiator valves - if present - must be set to the required temperature.



To change temperature within a room, turn the temperature setting knob to change the nominal room temperature.



Turn the setting knob towards + to raise the nominal temperature 1°C per graduation.



Likewise, turn the setting knob toward - to lower the nominal temperature by 1°C per graduation.

NOTE! Before making any new adjustments, wait some time, allowing the room temperature to adapt.

With the temperature setting knob, you only adjust the nominal room temperature. The reduced room temperature will not be changed. The temperature is displayed only if the room temperature controller operates in automatic mode or with manual operation.

## Presence Button:

Used to reduce the temperature in an unused room and save energy. Pressing the button once will switch between nominal temperature mode  $\blacktriangle$  and reduced temperature mode  $\blacktriangledown$

In manual operation the selection made acts continuously, in automatic mode only until the next switching action to the heating program takes place.

## Parameter Settings for the End-User: QAA70 Programmable Room Sensor

Note: To set the parameters of the QAA70, the unit cover must be open.

As soon as the cover is opened, the display and the button function will change, the framed number indicating the program line that can be selected with the up and down arrow keys.

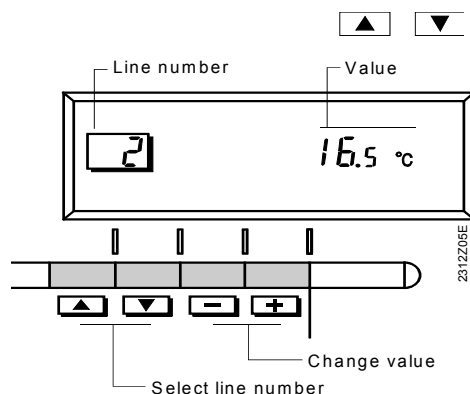

The following values can be set or displayed:

Temperatures	<b>1</b>	to	<b>3</b>
Heating program	<b>4</b>	to	<b>10</b>
Weekday and clock	<b>11</b>	to	<b>12</b>
Current values	<b>13</b>	to	<b>15</b>
Duration of holiday period			<b>16</b>
Resetting to default values			<b>17</b>

## Setting the Temperatures

Before making any room temperature readjustments on the controller, thermostatic radiator valves - if present - must be set to the required temperature.

In automatic mode, the controller switches between nominal and reduced room temperature according to the heating program.

- 1** Nominal Temperature: Room temperature during room occupancy times.
- 2** Reduced Temperature: Room temperature during absence or at night.
- 3** D.h.w Temperature: Required d.h.w. temperature. (only for controllers with d.h.w. function)

## Heating Program

The heating program can set predetermined temperature changeover times for one week. The seven-day program consists of a seven-day block (1-7) in which every day uses the same program, or single days (1...7) with seven individual 24-hour programs (1 = Monday...7 = Sunday).

Each 24-hour program offers three heating periods each of which is defined by a start and an end time. If no heating is required in a period the start time and end time should be set the same.

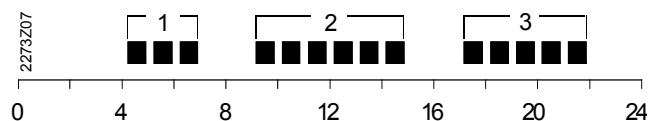

- 4** Select the respective day for the heating period. You have the choice of the seven-day block (1-7) and of individual days (1... 7) (1 = Monday ...7 = Sunday)
- 5** **Start of heating period 1:** Heating to the nominal temperature
- 6** **End of heating period 1:** Heating to the reduced temperature.
- 7** **Start of heating period 2:** Heating to the normal temperature
- 8** **End of heating period 2:** Heating to the reduced temperature
- 9** **Start of heating period 3:** Heating to the normal temperature
- 10** **End of heating period 3:** Heating to the reduced temperature

## Setting the time of day



- 11** For setting the current weekday (1 = Monday... 7 = Sunday)
- 12** For setting the current hour and minute

With the - (minus) and + (plus) buttons you can set the correct time of day. Continuous pressing of these buttons accelerates the display.

## Actual Values

- 13** Display of actual d.h.w. temperature
- 14** Display of actual boiler temperature
- 15** Display of actual flow temperature

## Holiday Function

- 16** For entering the number of days which you will be absent.
-  The display shows the holiday symbol, the first day of the holiday period on the left (1 = Monday... 7 = Sunday), and the number of days of the holiday period on the right.
-  During the holiday period, the controller switches to standby.
-  At the end of the holiday period, the controller switches to the automatic mode.

The holiday function can be cancelled by pressing any of the operating mode buttons.





### Retrieving the Default Values

 To retrieve the default values, press - (minus) and + (plus) simultaneously for at least 3 seconds.



 As a confirmation the display shows

**CAUTION: Retrieving default values will result in the values of the following line numbers being lost.**

Temperature and timer programs  to 

Duration of holiday period 

### Default Values

Designation	Icon	Value	Unit
Nominal temperature		20	°C
Reduced temperature		14	°C
D.h.w. temperature		60	°C
Working day program (days 1 - 5)	On Off On Off On Off	06:00 22:00 24:00 24:00 24:00 24:00	hh:mm
Weekend program (days 6—7)	On Off On Off On Off	08:00 23:00 24:00 24:00 24:00 24:00	hh:mm

### Status Display

#### No display

No power at the heating controller  
Faulty connection between room unit and heating controller  
Room unit and heating controller not compatible

#### Display Reads 'Off'

Heating controller's operating mode is not set to manual operation.

#### Display Shows 3 Dashes

No sensor connected or sensor faulty

#### Display Reads 'E'

Remote telephone switch (external contact) active.



#### Display Flashes 'r'





Room unit is in the initialization phase (rotating circle)

### Operation by the Heating Engineer

The QAA70 room unit has a service and parameter setting level to give the heating engineer additional setting choices. This level can only be activated by pressing a certain combination of buttons.

### Activating the Service and Parameter Setting Level

  Keep the Up and Down buttons depressed for at least 5 seconds. This will activate the service and parameter setting level.

  Then press the same arrowed Up and Down buttons to select the individual entry line and adjust the values by pressing + (plus) or - (minus).  
 

## Settings

**51** **Device Address for the PPS interface:** This line is used for setting the PPS address (for QAA70 room units connected to RVA... controller, default address 1 should not be changed).

The display shows the status of the PPS:

- Colon flashing at one-second intervals = communication ok.
- Steady or missing colon = ready to communicate
- Steady hyphens = communication interrupted.

**52** **Device Identification:**  
The display shows the identification number and the software-version.

**53** **Programming lock enduser level 2:**  
When activated the programming lock (parameter 53 = 1), all parameters can be displayed but not changed.  
When pressing '+' or '-', the display will show OFF.

**▲** **+** CAUTION! The operating lock can temporarily be deactivated. This is accomplished by simultaneously pressing the Up button and '+' for at least 5 seconds.

To cancel the operating lock, parameter 53 must be set to 0.

**55** The freely programmable input (terminals D3 and D4) permits the application of three different functions. The parameter has the following meaning:  
1 = Connection of an external sensor type QAW44; the display shows the temperature acquired by the external sensor. (\_\_\_ = no sensor connected, function deactivated)

2 = Using an external contact, changeover to the reduced temperature can be accomplished; the display shows the current status of the external contact (ooo = contact CLOSED, \_\_\_ = contact OPEN).

3. Using an external contact, changeover to the frost protection temperature can be accomplished; the display shows the current status of the external contact (ooo = contact CLOSED, \_\_\_ = contact OPEN)

AL = This function is not used.

**56** **Operating action of external contact:**  
If input D3/D4 is connected to an external potential-free contact (parameter 55 = 2 or 3), the operating action of the contact (remote telephone switch or window switch) can be selected.; the operating action designates the contact status at which the required function is active. (ooo = contact CLOSED, \_\_\_ = contact OPEN)

**57** **Influence of external room temperature sensor:**  
Determines the mixing ration of internal and external room temperature sensor if parameter 55 = 1.  
0 % = internal sensor only (0% external, 100% internal).  
50 % = mean value of external and internal sensor.  
100 % = external sensor only.  
For room temperature control and the display, the adjusted mix is used.  
If the external sensor is affected by a short-circuit or an open-circuit, the internal sensor will be used to unsure operation.

**58** Display of setpoint:  
This setting switches programming lines 1 and 2 (normal / reduced temperature) from the absolute display of the temperature to the relative display.

### Leaving the Service and Parameter Setting Level

When closing the unit cover, the service and parameter level will be quit and the new settings stored.

**NOTES**

--

**INSTALLER**

**SITE ADDRESS**

--

--

**BOILER TYPE**

**BOILER SIZE(S)**

**UNIT NO(S).**

**SERIAL NO(S).**

**FLUE**

--

--

--

--

--

**Activating the Service and Parameter Setting Level**